

Foamed PVC Skirting Board

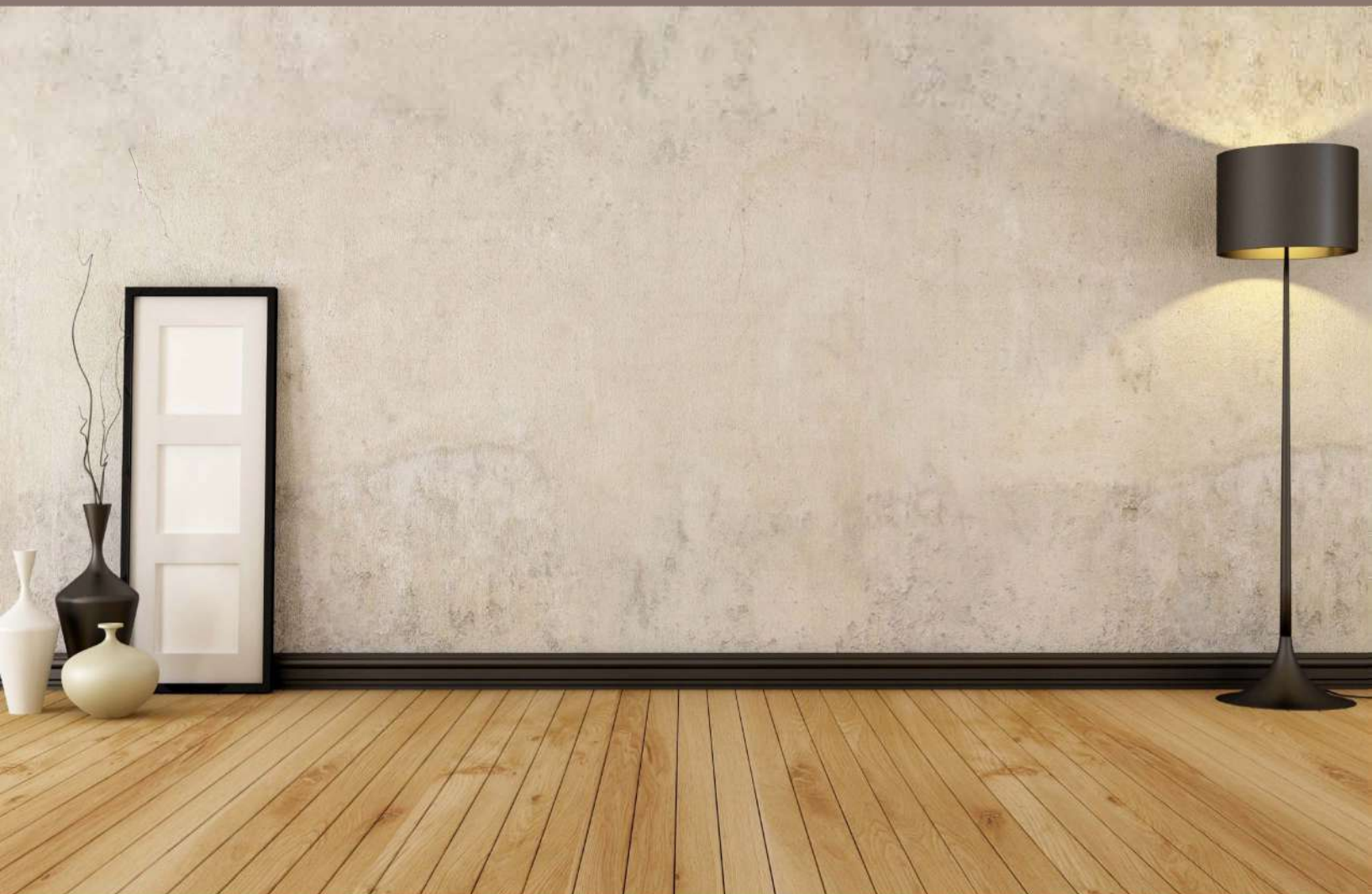

F40-A

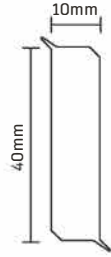

Packing : 20pcs/carton,2.5m/piece
Size/carton : 2515*178*57mm
G.W/carton : 18.9kgs
System : Flat Design

F40-B

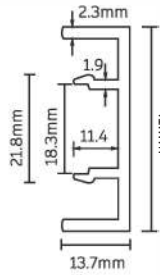

Packing : 40pcs/carton,2.5m/piece
Size/carton : 2515*183*96mm
G.W/carton : 28.5kgs
System : With Clip

F40-C

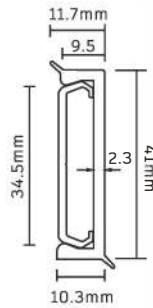

Packing : 40pcs/carton,2.2m/piece
Size/carton : 2215*190*84mm
G.W/carton : 15.7kgs
System : With Clip

F50-A



Packing : 20pcs/carton,2.5m/piece
Size/carton : 2515*104*89mm
G.W/carton : 7.4kgs
System : With Clip



F50-B

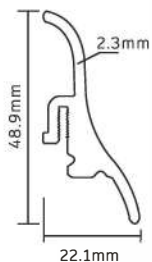

Packing : 40pcs/carton,2.5m/piece
Size/carton : 2515*212*97mm
G.W/carton : 18.5kgs
System : With Clip



F50-C



Packing : 30pcs/carton,2.5m/piece
Size/carton : 2515*161*130mm
G.W/carton : 24.7kgs
System : With Strip



F50-D

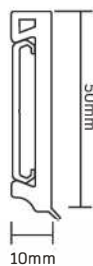

Packing : 30pcs/carton,2.5m/piece
Size/carton : 2515*158*108mm
G.W/carton : 21.5kgs
System : With Clip



F50-E

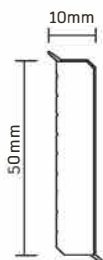

Packing : 24pcs/carton,2.5m/piece
Size/carton : 2515*162*84mm
G.W/carton : 34.6kgs
System : Flat design

F55-A

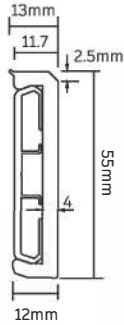

Packing : 30pcs/carton, 2.5m/piece
Size/carton : 2515*186*92mm
G.W/carton : 23kgs
System : With Base



F60-A

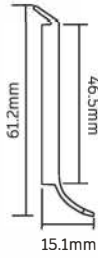

Packing : 20pcs/carton, 2.9m/piece
Size/carton : 2915*133*58mm
G.W/carton : 10.9kgs
System : Flat Design



F60-B

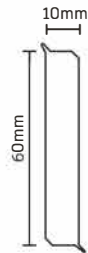

Packing : 20pcs/carton, 2.5m/piece
Size/carton : 2515*252*57mm
G.W/carton : 21kgs
System : Flat Design

F60-C

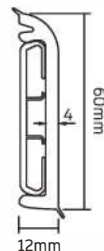

Packing : 30pcs/carton, 2.5m/piece
Size/carton : 2515*208*84mm
G.W/carton : 21.9kgs
System : With Clip

F60-D

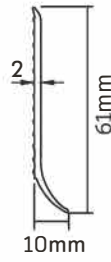

Packing : 60pcs/carton,2.5m/piece
Size/carton : 2510*136*82mm
G.W/carton : 17kgs
System : Flat design

F68-A

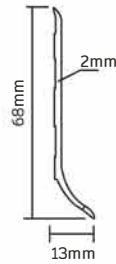

Packing : 50pcs/carton,2.9m/piece
Size/carton : 2915*149*71mm
G.W/carton : 20.1kgs
System : Flat Design

F70-A

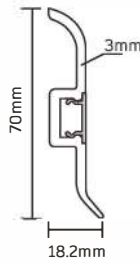

Packing : 40pcs/carton,2.5m/piece
Size/carton : 2515*244*126mm
G.W/carton : 31kgs
System : With Strip



F70-A-PA

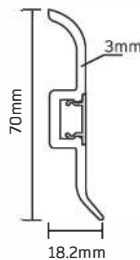

Packing : 40pcs/carton,2.5m/piece
Size/carton : 2515*244*126mm
G.W/carton : 31kgs
System : With PVC Strip,
 Aluminum Colored



F70-B

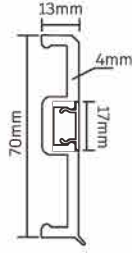

Packing : 20pcs/carton,2.5m/piece
Size/carton : 2520*163*109mm
G.W/carton : 26kgs
System : With Strip



F70-C

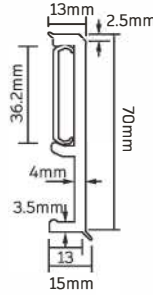

Packing : 20pcs/carton,2.5m/piece
Size/carton : 2515*156*109mm
G.W/carton : 17.7kgs
System : With Clip

F70-D

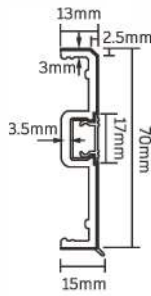

Packing : 20pcs/carton,2m/piece
Size/carton : 2015*160*106mm
G.W/carton : 14.4kgs
System : With Strip

F75-A

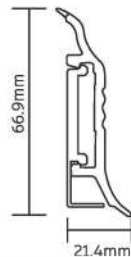

Packing : 48pcs/carton,2.2m/piece
Size/carton : 2350*216*132mm
G.W/carton : 19kgs
System : With Clip



F75-B

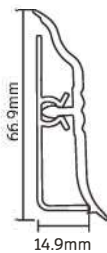

Packing : 24pcs/carton, 2.2m/piece
Size/carton : 2220*204*133mm
G.W/carton : 24.3kgs
System : With Base



F75-C

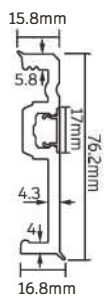

Packing : 20pcs/carton, 2.5m/piece
Size/carton : 2515*181*120mm
G.W/carton : 28kgs
System : With Strip

F75-D

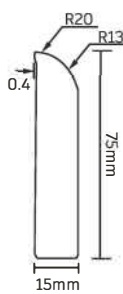

Packing : 12pcs/carton, 2.5m/piece
Size/carton : 2515*155*98mm
G.W/carton : 32.5kgs
System : Flat Design

F75-E

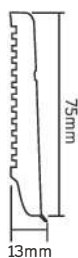

Packing : 20pcs/carton, 2.5m/piece
Size/carton : 2515*161*98mm
G.W/carton : 33kgs
System : Flat Design

F80-A

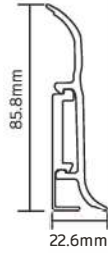

Packing : 32pcs/carton,2.2m/piece
Size/carton : 2400*185*136mm
G.W/carton : 22.5kgs
System : With Clip



F80-B

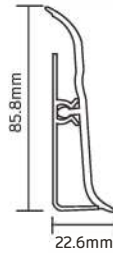

Packing : 20pcs/carton,2.2m/piece
Size/carton : 2220*176*156mm
G.W/carton : 28kgs
System : With Base



F80-C

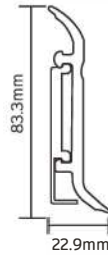

Packing : 24pcs/carton,2.2m/piece
Size/carton : 2320*183*114mm
G.W/carton : 21.5kgs
System : With Clip



F80-D

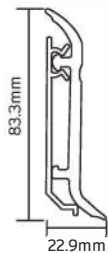

Packing : 16pcs/carton,2.7m/piece
Size/carton : 2715*170*122mm
G.W/carton : 26.4kgs
System : With Base



F80-E

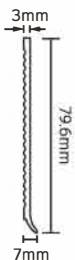

Packing : 30pcs/carton, 2.95m/piece
Size/carton : 2960*169*56mm
G.W/carton : 19.5kgs
System : Flat Design

F80-F

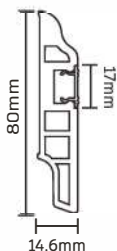

Packing : 24pcs/carton, 2.95m/piece
Size/carton : 2960*236*120mm
G.W/carton : 36.5kgs
System : With Strip

F80-G

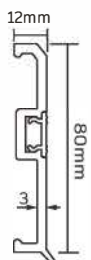

Packing : 24pcs/carton, 2.5m/piece
Size/carton : 2515*184*104mm
G.W/carton : 28.6kgs
System : With Strip



F80-H

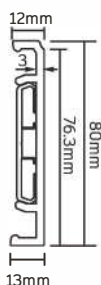

Packing : 20pcs/carton, 2.5m/piece
Size/carton : 2515*174*96mm
G.W/carton : 18.4kgs
System : With Base

F80-J

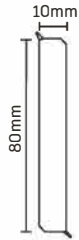

Packing : 15pcs/carton,2.4m/piece
Size/carton : 2415*250*57mm
G.W/carton : 32.5kgs
System : Flat design

F85-A



Packing : 40pcs/carton,2.9m/piece
Size/carton : 2915*174*94mm
G.W/carton : 23.7kgs
System : Flat Design

F85-B

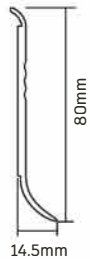

Packing : 40pcs/carton,2.9m/piece
Size/carton : 2915*170*74mm
G.W/carton : 24.9kgs
System : Flat Design

F90-A

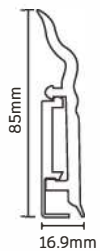

Packing : 20pcs/carton,2.5m/piece
Size/carton : 2730*188*110mm
G.W/carton : 17.5kgs
System : With Clip



F90-B

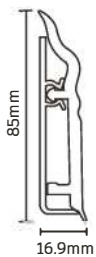

Packing : 20pcs/carton, 2.5m/piece
Size/carton : 2515*184*179mm
G.W/carton : 28kgs
System : With Base



F90-C

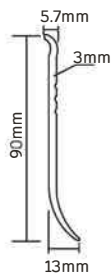

Packing : 20pcs/carton, 2.9m/piece
Size/carton : 2920*102*73mm
G.W/carton : 10.6kgs
System : Flat Design

F90-D

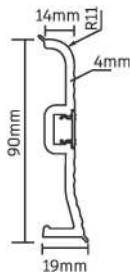

Packing : 20pcs/carton, 2.5m/piece
Size/carton : 2515*202*137mm
G.W/carton : 32.4kgs
System : With Strip

F95-A

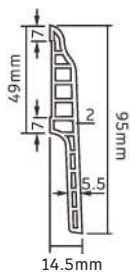

Packing : 20pcs/carton, 2.9m/piece
Size/carton : 2915*151*127mm
G.W/carton : 35.5kgs
System : Flat Design

F100-A

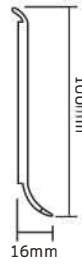

Packing : 40pcs/carton,2.9m/piece
Size/carton : 2912*234*94mm
G.W/carton : 45.7kgs
System : Flat Design

F100-B

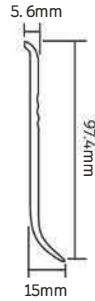

Packing : 40pcs/carton,2.9m/piece
Size/carton : 2915*210*76mm
G.W/carton : 29.5kgs
System : Flat Design

F100-C

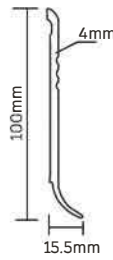

Packing : 30pcs/carton,2.9m/piece
Size/carton : 2910*214*77mm
G.W/carton : 31kgs
System : Flat Design

F100-D

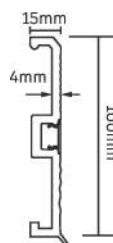

Packing : 20pcs/carton,2.95m/piece
Size/carton : 2960*211*161mm
G.W/carton : 31kgs
System : With Strip



F100-E

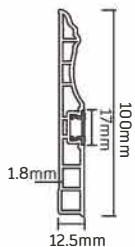

Packing : 20pcs/carton, 2.9m/piece
Size/carton : 2915*203*121mm
G.W/carton : 36.8kgs
System : With Strip

F100-E-PA

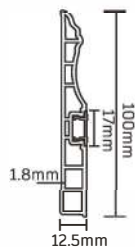

Packing : 20pcs/carton, 2.9m/piece
Size/carton : 2915*203*121mm
G.W/carton : 36.8kgs
System : With PVC Strip, Aluminum colored

F100-F

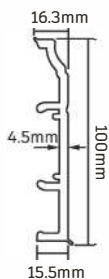

Packing : 20pcs/carton, 2.5m/piece
Size/carton : 2515*221*124mm
G.W/carton : 34kgs
System : With Clip



F100-G

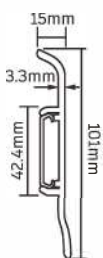

Packing : 20pcs/carton, 2.5m/piece
Size/carton : 2515*209*104mm
G.W/carton : 24.4kgs
System : With Clip

F100-H

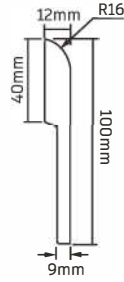

Packing : 12pcs/carton,2m/piece
Size/carton : 2015*205*62mm
G.W/carton : 23kgs
System : Flat Design

F100-I

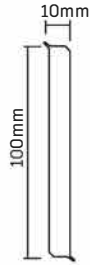

Packing : 10pcs/carton,2m/piece
Size/carton : 2015*207*57mm
G.W/carton : 22.7kgs
System : Flat Design

F120-A

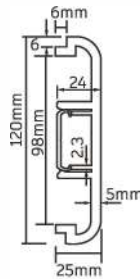

Packing : 12pcs/carton,2.5m/piece
Size/carton : 2515*268*118mm
G.W/carton : 34.1kgs
System : With Clip



F130-A

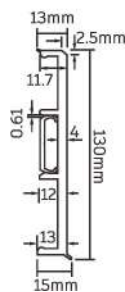

Packing : 12pcs/carton,2.5m/piece
Size/carton : 2515*140*114mm
G.W/carton : 37kgs
System : Flat Design

Hard PVC Skirting Board



P44-A

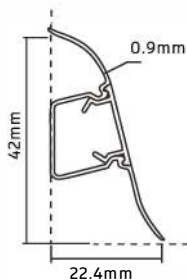

Packing : 32pcs/carton,2.5m/piece

Size/carton : 2515*141*118mm

G.W/carton : 15kgs

System : With Strip



P50-B

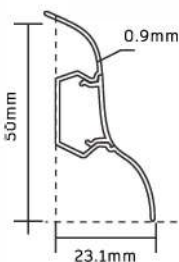

Packing : 40pcs/carton,2.5m/piece

Size/carton : 2515*169*122mm

G.W/carton : 16.9kgs

System : With Strip



P50-D

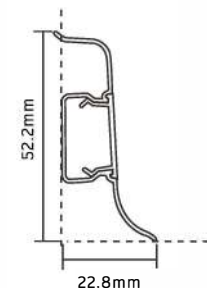

Packing : 40pcs/carton,2.5m/piece

Size/carton : 2515*177*133mm

G.W/carton : 19.1kgs

System : With Strip



P50-F

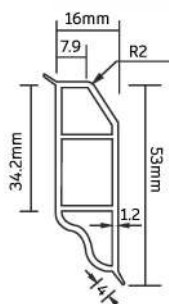

Packing : 40pcs/carton,2.5m/piece

Size/carton : 2515*162*168mm

G.W/carton : 24.5kgs

System : Flat design

P55-A

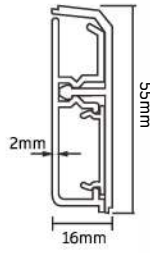

Packing : 20pcs/carton,2.2m/piece
Size/carton : 2215*217*90mm
G.W/carton : 29.5kgs
System : With Base



P60-A

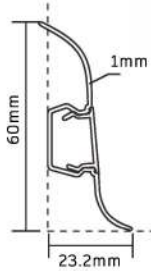

Packing : 40pcs/carton,2.5m/piece
Size/carton : 2515*185*132mm
G.W/carton : 18.8kgs
System : With Strip



P60-B

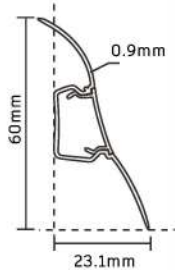

Packing : 40pcs/carton,2.5m/piece
Size/carton : 2515*178*134mm
G.W/carton : 18.5kgs
System : With Strip



P60-D

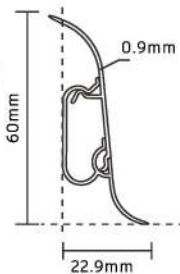

Packing : 40pcs/carton,2.5m/piece
Size/carton : 2515*196*129mm
G.W/carton : 21.8kgs
System : Seperate Design



P60-E

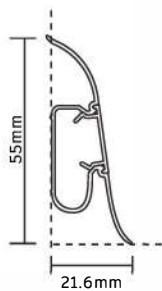

Packing : 40pcs/carton,2.5m/piece

Size/carton : 2515*236*104mm

G.W/carton : 19.7kgs

System : With Strip



P60-F

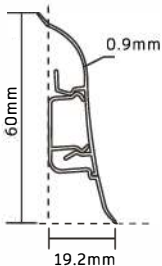

Packing : 40pcs/carton,2.5m/piece

Size/carton : 2515*198*142mm

G.W/carton : 24.5kgs

System : Seperate design



P60-G

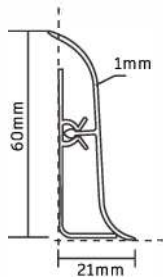

Packing : 40pcs/carton,2.5m/piece

Size/carton : 2512*221*128mm

G.W/carton : 27kgs

System : With Base



P60-H

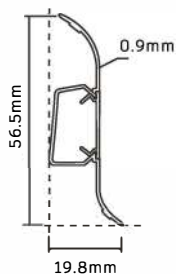

Packing : 40pcs/carton,2.5m/piece

Size/carton : 2512*179*136mm

G.W/carton : 17kgs

System : With Strip



P60-I

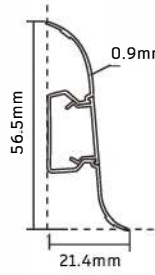

Packing : 40pcs/carton,2.5m/piece
Size/carton : 2515*183*140mm
G.W/carton : 17.5kgs
System : With Strip



P60-J

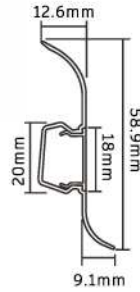

Packing : 40pcs/carton,2.5m/piece
Size/carton : 2515*182*130mm
G.W/carton : 21.8kgs
System : With Strip

P60-K

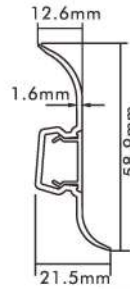

Packing : 30pcs/carton,2.5m/piece
Size/carton : 2515*190*94mm
G.W/carton : 27.5kgs
System : With Strip



P62-A

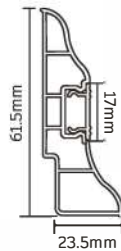

Packing : 30pcs/carton,2.95m/piece
Size/carton : 2960*190*150mm
G.W/carton : 30.9kgs
System : With Strip



P62-B

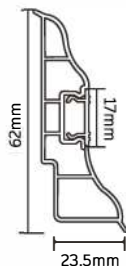

Packing : 30pcs/carton, 2.95m/piece

Size/carton : 2960*190*150mm

G.W/carton : 31.1kgs

System : With Strip



P65-B

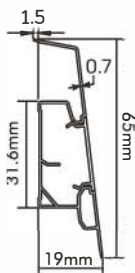

Packing : 40pcs/carton, 2.5m/piece

Size/carton : 2515*236*166mm

G.W/carton : 26kgs

System : With Strip

P68-B

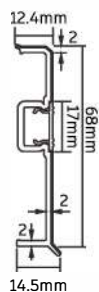

Packing : 20pcs/carton, 2.5m/piece

Size/carton : 2515*154*85mm

G.W/carton : 22.5kgs

System : With Strip

P70-A

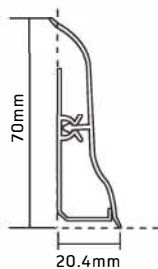

Packing : 20pcs/carton, 2.5m/piece

Size/carton : 2515*156*126mm

G.W/carton : 16.7kgs

System : With Base



P70-B

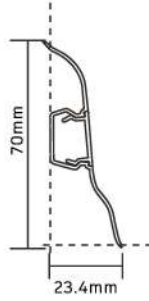

Packing : 40pcs/carton,2.5m/piece
Size/carton : 2515*230*99mm
G.W/carton : 24.1kgs
System : With Strip



P70-C

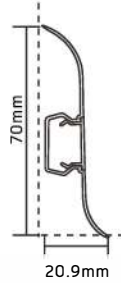

Packing : 40pcs/carton,2.5m/piece
Size/carton : 2515*229*130mm
G.W/carton : 22.9kgs
System : With Strip



P70-D

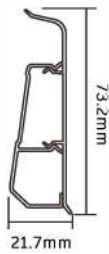

Packing : 24pcs/carton,2.5m/piece
Size/carton : 2515*250*110mm
G.W/carton : 21kgs
System : With Base



P70-E

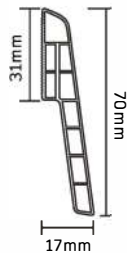

Packing : 16pcs/carton,2.8m/piece
Size/carton : 2815*209*56mm
G.W/carton : 15.4kgs
System : Flat Design

P70-F

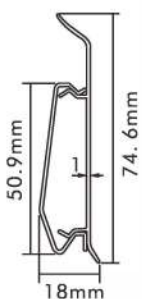

Packing : 20pcs/carton, 2.5m/piece
Size/carton : 2515*264*66mm
G.W/carton : 15.5kgs
System : With Base



P70-G

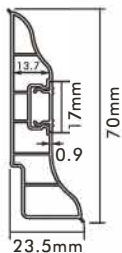

Packing : 30pcs/carton, 2.8m/piece
Size/carton : 2815*226*146mm
G.W/carton : 34.9kgs
System : With Strip

P72-A

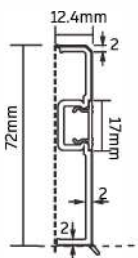

Packing : 20pcs/carton, 2m/piece
Size/carton : 2015*156*88mm
G.W/carton : 19.3kgs
System : With Strip



P72-B

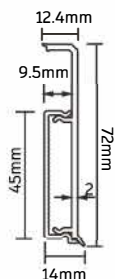

Packing : 30pcs/carton, 2.5m/piece
Size/carton : 2515*224*64mm
G.W/carton : 26kgs
System : With Base



P72-C

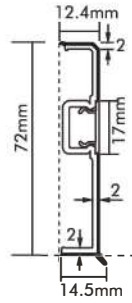

Packing : 20pcs/carton,2m/piece
Size/carton : 2015*156*88mm
G.W/carton : 19.3kgs
System : With Strip

P75-A

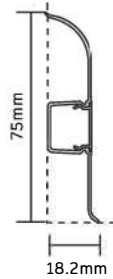

Packing : 40pcs/carton,2.5m/piece
Size/carton : 2515*264*88mm
G.W/carton : 22.1kgs
System : With Strip



P77-A

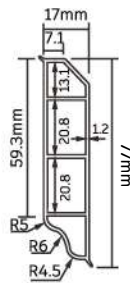

Packing : 20pcs/carton,2.5m/piece
Size/carton : 2515*156*176mm
G.W/carton : 21.9kgs
System : Flat Design

P80-A

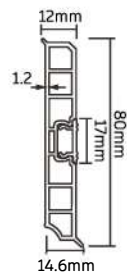

Packing : 24pcs/carton,2.95m/piece
Size/carton : 2960*240*106mm
G.W/carton : 34.5kgs
System : With Strip

P80-B

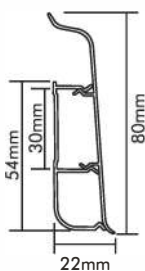

Packing : 20pcs/carton, 2.5m/piece
Size/carton : 2515*209*91mm
G.W/carton : 18kgs
System : With Base

P80-C

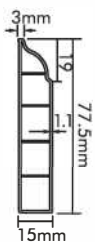

Packing : 18pcs/carton, 2.4m/piece
Size/carton : 2415*240*96mm
G.W/carton : 20kgs
System : Flat design

P80-D

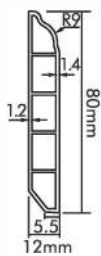

Packing : 20pcs/carton, 2.5m/piece
Size/carton : 2515*162*124mm
G.W/carton : 25kgs
System : Flat design

P83-A

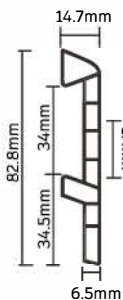

Packing : 20pcs/carton, 2.5m/piece
Size/carton : 2515*169*114mm
G.W/carton : 17.7kgs
System : With Clip



P88-A

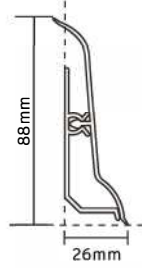

Packing : 20pcs/carton, 2.4m/piece
Size/carton : 2415*194*129mm
G.W/carton : 22.2kgs
System : With Base



P88-B

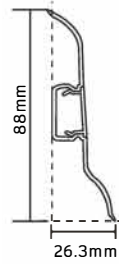
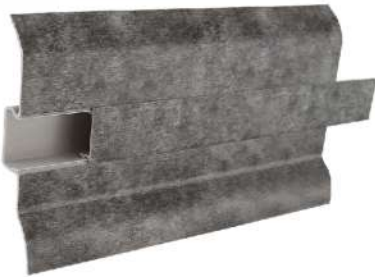

Packing : 20pcs/carton, 2.5m/piece
Size/carton : 2515*214*94mm
G.W/carton : 15.5kgs
System : With Strip



P88-C

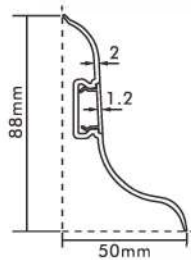

Packing : 20pcs/carton, 2.5m/piece
Size/carton : 2515*193*97mm
G.W/carton : 27kgs
System : With Strip

P90-A

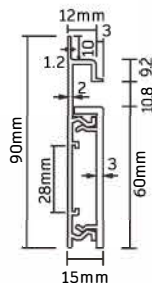

Packing : 12pcs/carton, 2.8m/piece
Size/carton : 2815*176*91mm
G.W/carton : 33.5kgs
System : With Base

P90-B

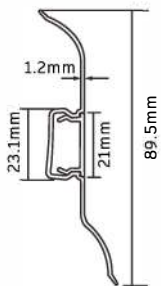

Packing : 20pcs/carton,2.8m/piece
Size/carton : 2815*234*84mm
G.W/carton : 16.5kgs
System : With Strip

P90-C

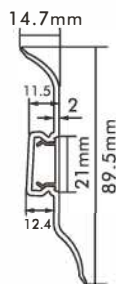

Packing : 20pcs/carton,2.5m/piece
Size/carton : 2515*193*97mm
G.W/carton : 27kgs
System : With Strip

P90-D

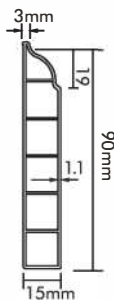

Packing : 18pcs/carton,2.4m/piece
Size/carton : 2415*263*96mm
G.W/carton : 22kgs
System : Flat design

P95-A

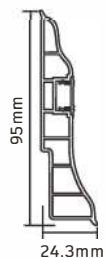

Packing : 20pcs/carton,2.9m/piece
Size/carton : 2915*196*144mm
G.W/carton : 27.8kgs
System : With Strip



P95-A-AL



Packing : 20pcs/carton,2.9m/piece
Size/carton : 2915*196*144mm
G.W/carton : 27.8kgs
System : With Aluminum Strip



P95-C

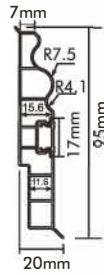

Packing : 20pcs/carton,2.9m/piece
Size/carton : 2915*192*164mm
G.W/carton : 26.6kgs
System : With Strip

P95-D

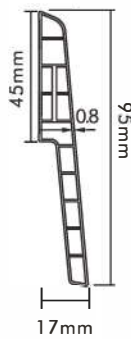

Packing : 20pcs/carton,2.5m/piece
Size/carton : 2515*144*136mm
G.W/carton : 24.4kgs
System : Flat design

P100-A

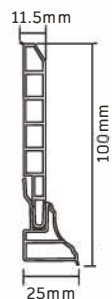

Packing : 20pcs/carton,2.9m/piece
Size/carton : 2915*221*137mm
G.W/carton : 37.9kgs
System : With Strip

P100-B

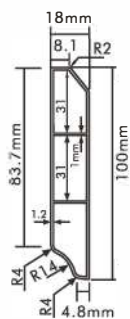

- Packing** : 18pcs/carton, 2.9m/piece
- Size/carton** : 2915*299*112mm
- G.W/carton** : 30kgs
- System** : Flat design

P120-A

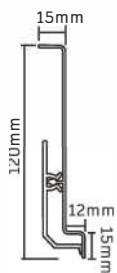

- Packing** : 20pcs/carton, 2.5m/piece
- Size/carton** : 2515*269*128mm
- G.W/carton** : 28.5kgs
- System** : With Base

KL-A

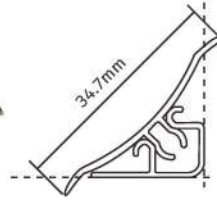

Packing : 60pcs/carton,2.5m/piece
Size/carton : 2515*223*68mm
G.W/carton : 21kgs
System : With Base



KL-B

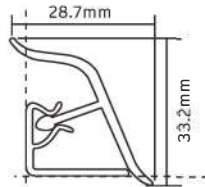

Packing : 20pcs/carton,2.5m/piece
Size/carton : 2515*185*108mm
G.W/carton : 18.8kgs
System : With Base



KL-C



Packing : 20pcs/carton,2.5m/piece
Size/carton : 2515*86*37mm
G.W/carton : 5.9kgs
System : With Base

KL-D

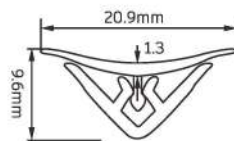

Packing : 60pcs/carton,2.5m/piece
Size/carton : 2512*156*50mm
G.W/carton : 19.8kgs
System : With Base

CM-60-A

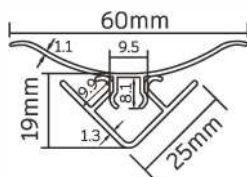

Packing : 20pcs/carton,2.9m/piece
Size/carton : 2912*196*144mm
G.W/carton : 35.8kgs
System : With Base

CM-80-A

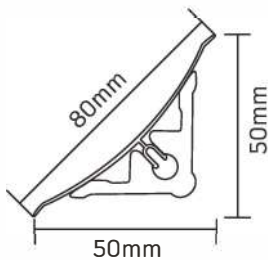
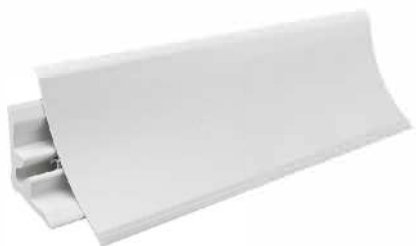

Packing : 20pcs/carton,2.9m/piece
Size/carton : 2912*196*144mm
G.W/carton : 35.22kgs
System : With Base

CM-80-B

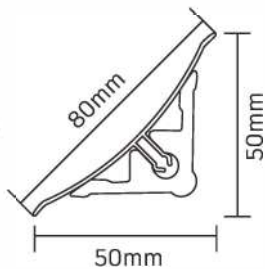
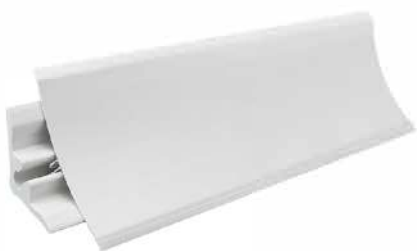

Packing : 20pcs/carton,2.9m/piece
Size/carton : 2912*196*144mm
G.W/carton : 35.36kgs
System : With Base

CM-80-C

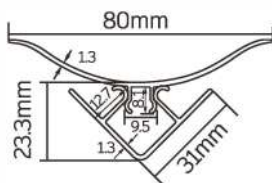

Packing : 20pcs/carton,2.9m/piece
Size/carton : 2915*221*137mm
G.W/carton : 34.2kgs
System : With Base

FLEXIBLE PVC SKIRTING BOARD & **DECORATIVE PROFILES**

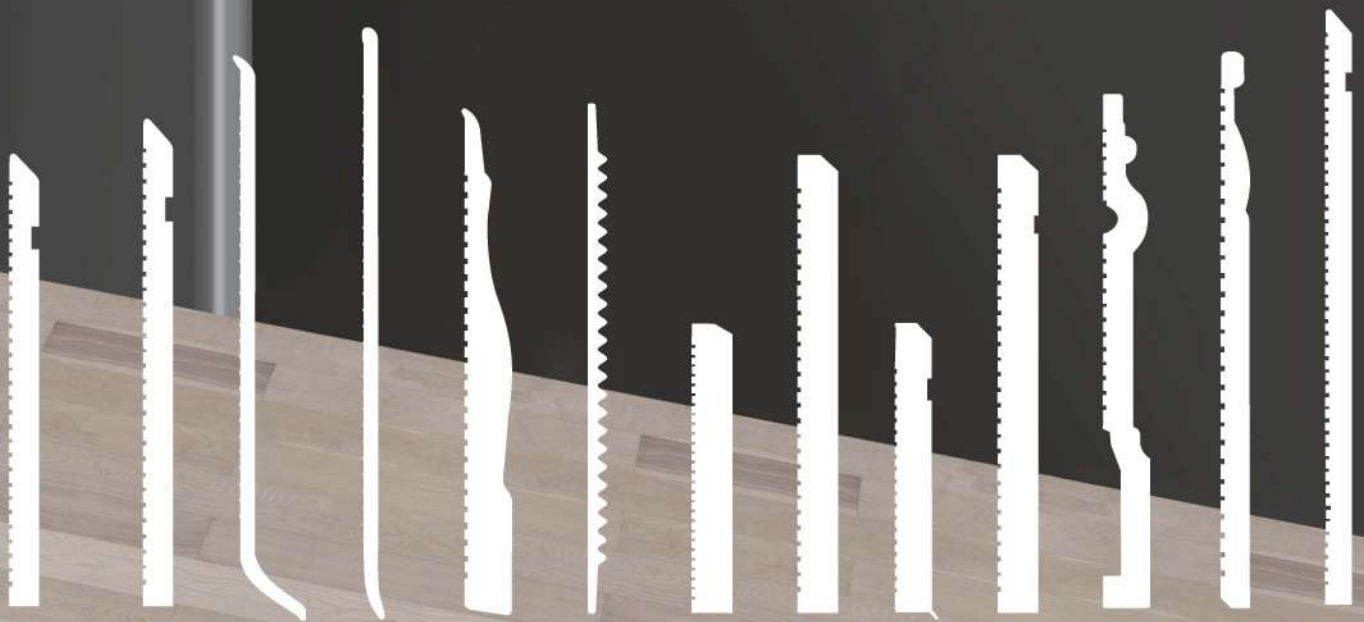

S100-A S108-A S120-B S120-C S108-B S100-E S76-D S114-A S76-E S114-B S120-A S133-A S153-A

FLEXIBLE PVC SKIRTING BOARD

Key features:

- Smooth surface ,will not fade, crack or shrink easily
- Durable and flexible
- A wide range of designs and colors available to meet demands.
- Environmental friendly, No heavy metal, no formaldehyde emission
- Easy to install ,suitable for homes, offices, hospitals or hotels decoration

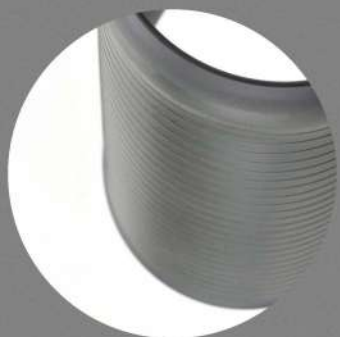

VWB-001 series-Convex back design

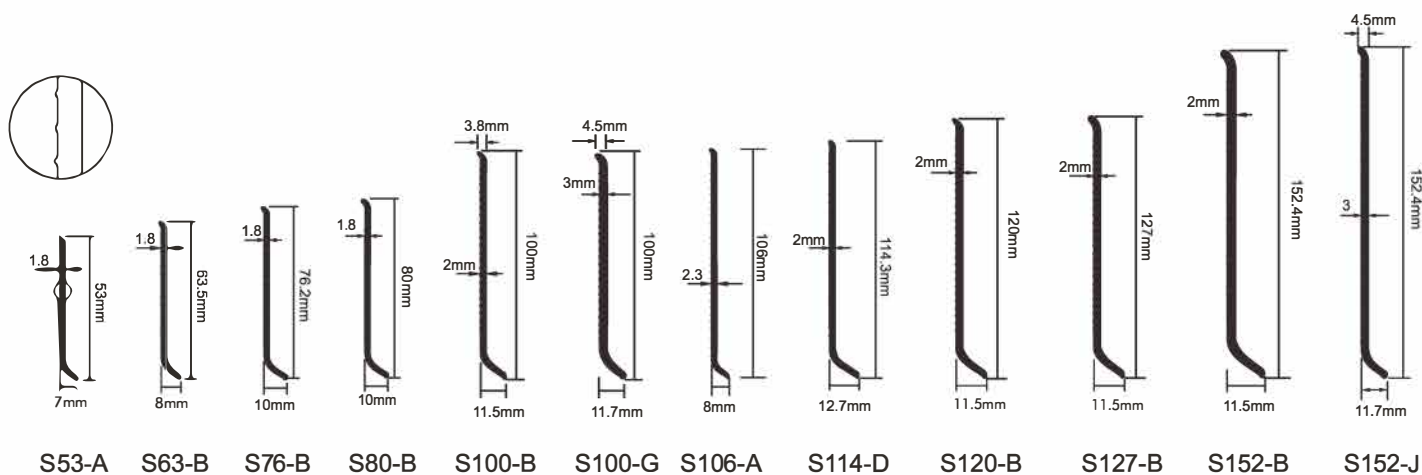

Item No.	Hight(mm)	Thickness(mm)	Packing	Size/carton(mm)	G.W/carton(kgs)
S53-A	53	1.8	1roll/50m	400*400*61	10
S63-B	63.5	1.8	1roll/50m		13
S76-B	76.2	1.8	1roll/50m	400*400*84	14.3
S80-B	80	1.8	1roll/50m	400*400*88	13.5
S100-B	100	114.3	1roll/50m	410*410*107	20.3
S100-G	100	3	1roll/40m	445*445*108	24
S106-A	106	2.3	1roll/30.5m	350*350*112	13.85
S114-D	114.3	2	1roll/50m	410*410*123	22.5
S120-B	120	2	1roll/50m	410*410*128	24.3
S127-B	127	2	1roll/50m	410*410*135	25.5
S152-B	152.4	2	1roll/50m	410*410*158	30
S152-J	152.4	3	1roll/40m	445*445*163	35.3



VWB-001 series- Concave back design

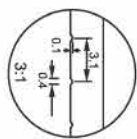

S63-D

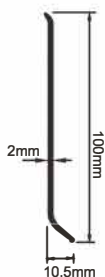

S100-H



S127-D



S127-F

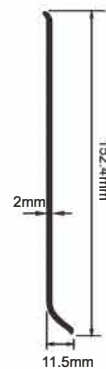

S152-E

Item No.	Hight(mm)	Thickness(mm)	Packing	Size/carton(mm)	G.W/carton(kgs)
S63-D	63.5		1roll/24.4m	305*305*73	6.35
S100-H	100		1roll/40m	410*410*107	20.3
S127-D	127		1roll/25m	390*390*135	23.5kgs
S127-F	127		25pcs/carton	1235*178*86	21.1
S152-E	152.4		1roll/25m	310*310*159.4	15



VWB-001 series-Flat back design

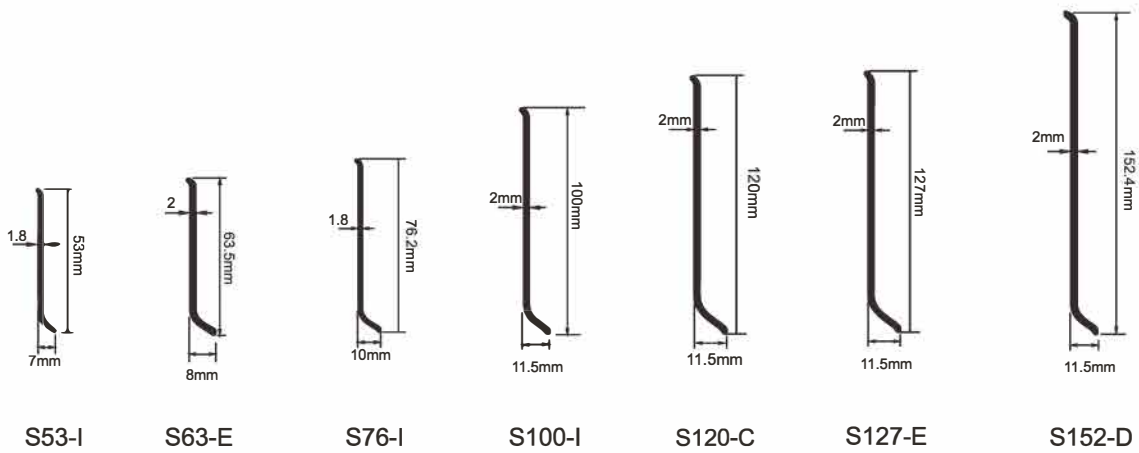

Item No.	Hight(mm)	Thickness(mm)	Packing	Size/carton(mm)	G.W/carton(kgs)
S53-I	53	1.8	1roll/50m	400*400*61	10
S63-E	63.5	2	1roll/24.4m	335*335*73	6.5
S76-I	76.2	1.8	1roll/3m*8roll	410*206*385	14
S100-I	100	2	1roll/40m	410*410*107	20.3
S120-C	120	2	1roll/50m	312*312*285	24.3
S127-E	127	2	1roll/50m	410*410*135	25.5
S152-D	152.4	2	1roll/25m	310*310*159.4	15

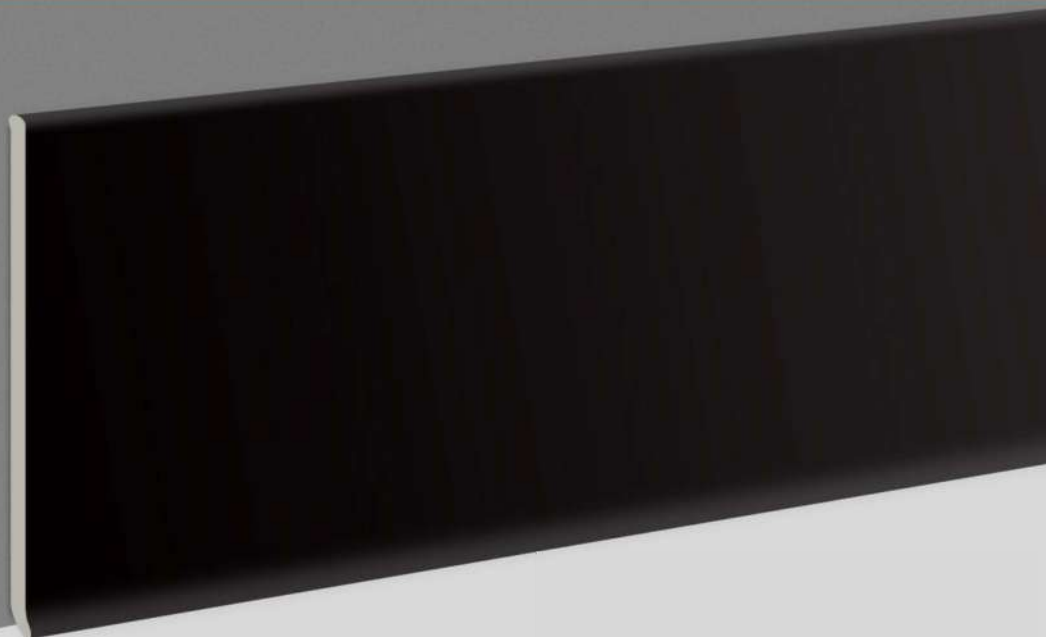

VWB-002 series-Flat back design



S100-K

Item No.	Hight(mm)	Thickness(mm)	Packing	Size/carton(mm)	G.W/carton(kgs)
S100-K	100	2	1roll/50m	410*410*106	19.3

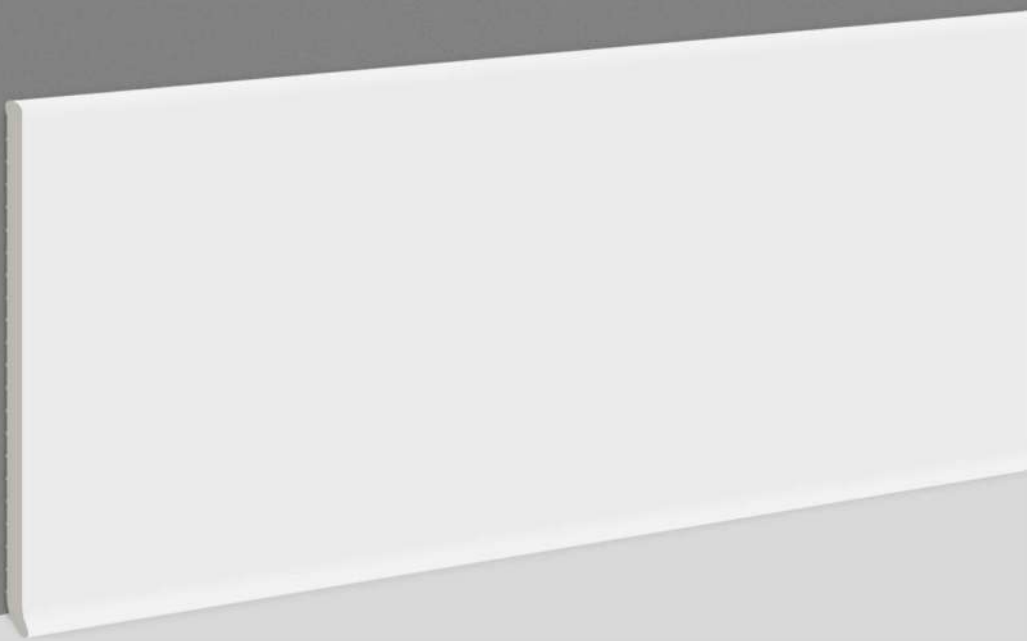
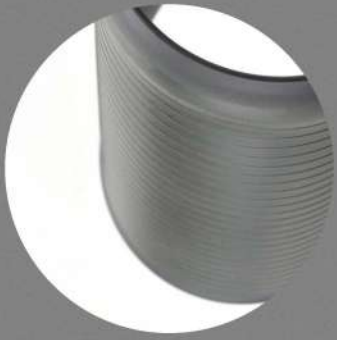

VWB-002 series-Convex back design

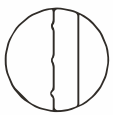

S63-C



S76-C

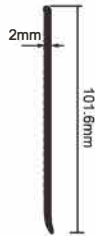

S100-C



S127-C



S152-C

Item No.	Hight(mm)	Thickness(mm)	Packing	Size/carton(mm)	G.W/carton(kgs)
S63-C	63.5	1.8	1roll/50m		12.5
S76-C	76.2	1.8	1roll/50m		14.8
S100-C	101.6	2	1roll/50m	410*410*106	20
S127-C	127	2	1roll/50m	410*410*135	24.8
S152-C	152.4	2	1roll/50m	410*410*158	29.5



VWB-003 series-Flat back design



S100-J

Item No.	Hight(mm)	Thickness(mm)	Packing	Size/carton(mm)	G.W/carton(kgs)
S100-J	100	6.5	1pcs/2.44m, 10pcs/carton	2465*106*74	28.6



VWB-003 series- Concave back design

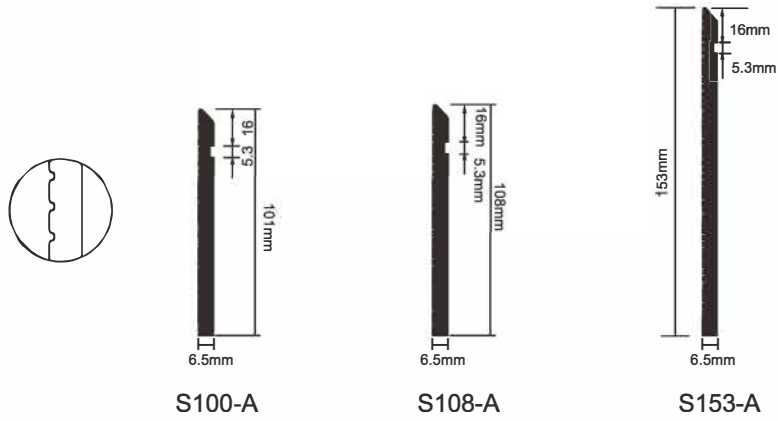

Item No.	Hight(mm)	Thickness(mm)	Packing	Size/carton(mm)	G.W/carton(kgs)
S100-A	101	6.5	1pcs/2.44m, 10pcs/carton	2465*106*74	28.6
S108-A	108	6.5	1pcs/2.44m, 8pcs/carton	2465*119*64	24.5
S153-A	153	6.5	1pcs/2.44m, 8pcs/carton	2465*163*60	34.8



VWB-003 series- Flat back , with soft strip

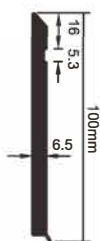

S100-U

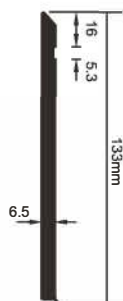

S133-E

Item No.	Hight(mm)	Thickness(mm)	Packing	Size/carton(mm)	G.W/carton(kgs)
S100-U	100	6.5	30.48m/roll, 1roll/carton	560*560*108	35.6
S133-E	133	6.5		560*560*141	47.5

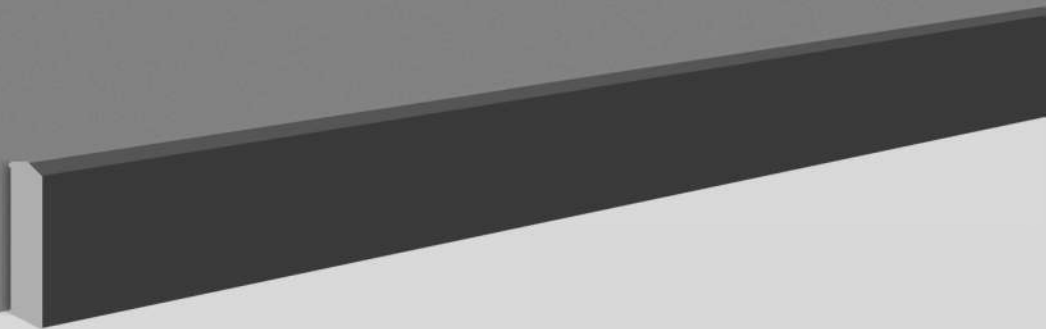

VWB-004 series-Flat back design

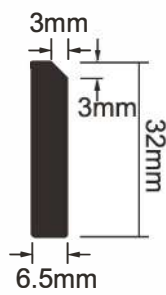

S32-C

Item No.	Hight(mm)	Thickness(mm)	Packing	Size/carton(mm)	G.W/carton(kgs)
S32-C	32	6.5	30.48m/roll,2roll/carton	540*540*75	24



VWB-004 series- Concave back design

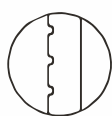

S76-D



S100-F



S114-A



S114-B

Item No.	Hight(mm)	Thickness(mm)	Packing	Size/carton(mm)	G.W/carton(kgs)
S76-D	76.2	9.5	1pcs/2.44m, 10pcs/carton	2465*159*51	32.5
S100-F	100	6.5	1pcs/2.44m, 10pcs/carton	2450*111*79	29.5
S114-A	114	9.5	1pcs/2.44m, 6pcs/carton	2465*124*67	29.5
S114-B	114	6.5	1pcs/2.44m, 8pcs/carton	2465*126*66	26.7



VWB-004 series- Flat back , with soft strip

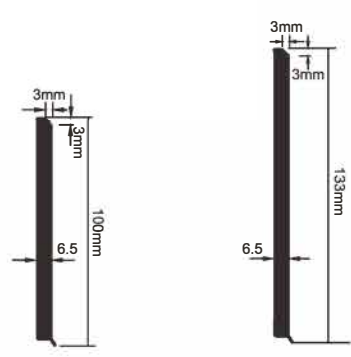

S100-T

S133-D

Item No.	Hight(mm)	Thickness(mm)	Packing	Size/carton(mm)	G.W/carton(kgs)
S100-T	100	6.5	30.48m/roll	560*560*108	36.5
S133-D	133	6.5		560*560*141	48.5



VWB-005 series-Flat back design



S63-F

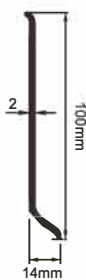

S100-L



S127-H

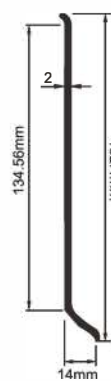

S152-H

Item No.	Hight(mm)	Thickness(mm)	Packing	Size/carton(mm)	G.W/carton(kgs)
S63-F	63.5	2	1roll/24.4m	300*300*74	6.35
S100-L	100	2	1roll/24.4m	300*300*112	10
S127-H	127	2	1roll/24.4m	335*335*142	13.5
S152-H	152.4	2	1roll/24.4m	300*300*163	14.6

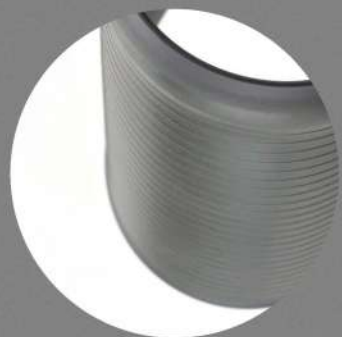

VWB-005 series- Convex back design

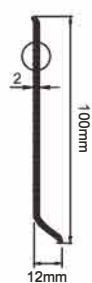
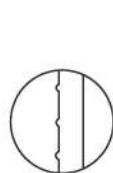

S100-N

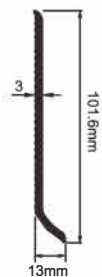

S102-F

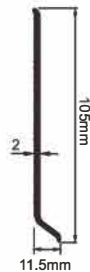

S105-A



S107-A

Item No.	Hight(mm)	Thickness(mm)	Packing	Size/carton(mm)	G.W/carton(kgs)
S100-N	100	2	1pcs/1.22m,30pcs/carton	1232*122*84	15.3
S102-F	101.6	3	1roll/5m	210*210*112	3.1
S105-A	105	2	1roll/40m	390*390*115	16.25
S107-A	106.7	3	1roll/30.5m	410*410*117	18.6

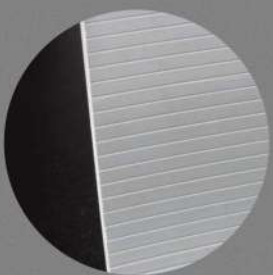

VWB-005 series- Concave back design

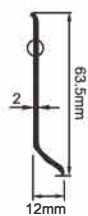
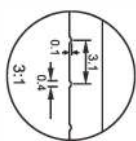

S63-G



S100-M

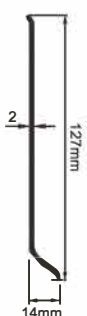

S127-G



S152-I

Item No.	Hight(mm)	Thickness(mm)	Packing	Size/carton(mm)	G.W/carton(kgs)
S63-G	63.5	2	1roll/24.4m	300*300*74	6.35
S100-M	100	2	1roll/24.4m	300*300*112	10
S127-G	127	2	1roll/24.4m	305*305*142	12.5
S152-I	152.4	2	1roll/24.4m	300*300*163	14.6

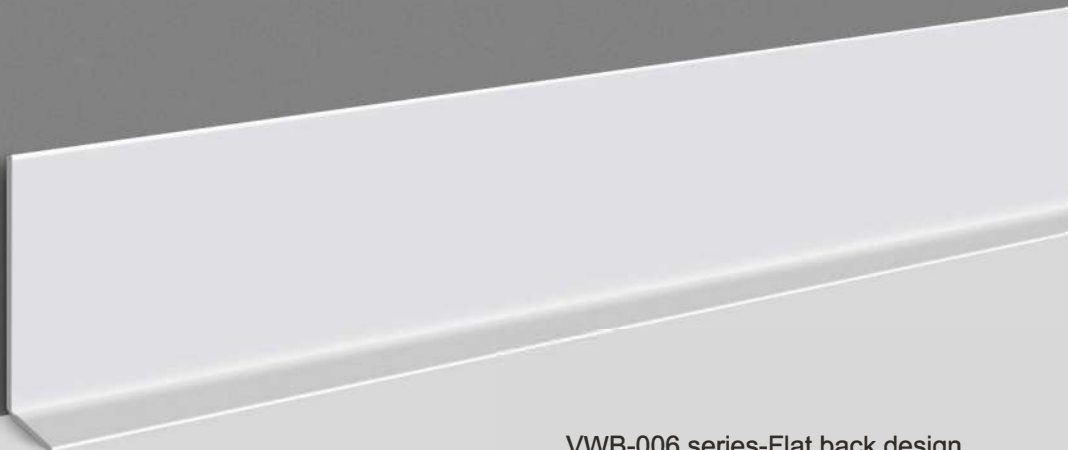

VWB-006 series-Flat back design

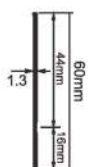

S60-B

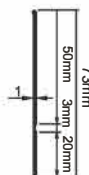

S73-A

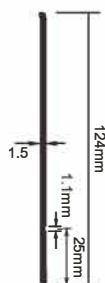

S124-A

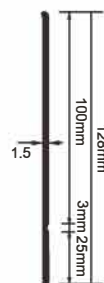

S128-A

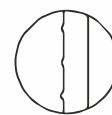

S65-A

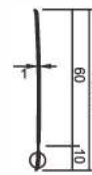

S70-A

Item No.	Hight(mm)	Thickness(mm)	Packing	Size/carton(mm)	G.W/carton(kgs)
S60-B	60	1.3	1roll/25m	555*285*235	27.7
S73-A	73	1	1roll/25m,6roll/carton	680*460*86	23
S124-A	124	1.5	1roll/12.2m,4roll/carton	450*230*286	14
S128-A	128	1.5	1roll/50m	380*380*132	19.3
S65-A	65	1	1roll/25m	240*240*77	3.5
S70-A	70	1	1roll/30m	255*255*366	4.1

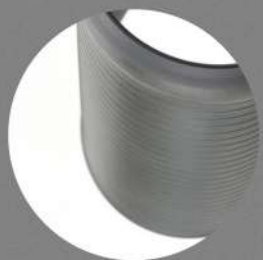

VWB-006 series- Convex back design

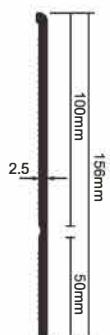
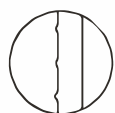

S156-A

Item No.	Hight(mm)	Thickness(mm)	Packing	Size/carton(mm)	G.W/carton(kgs)
S156-A	156	2.5	1roll/40m	410*410*162	29.3

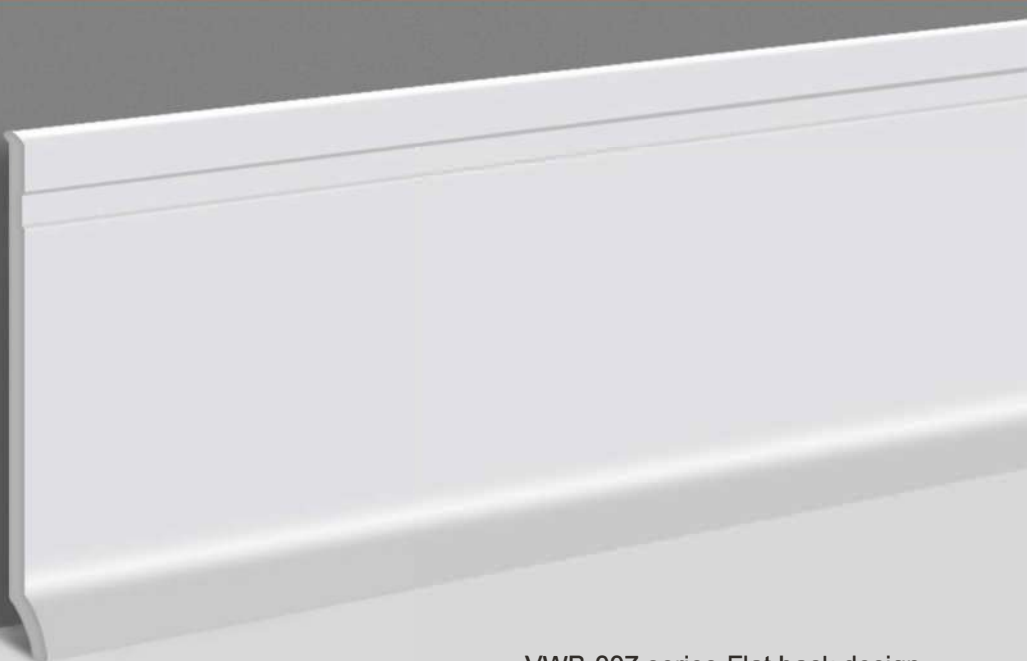

VWB-007 series-Flat back design

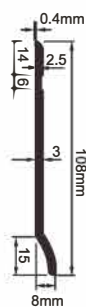

S108-C

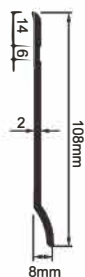

S108-I

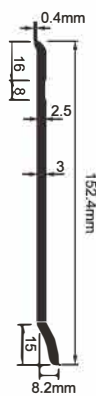

S152-F

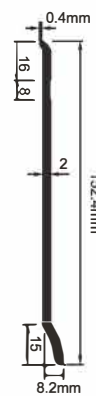

S152-K

Item No.	Hight(mm)	Thickness(mm)	Packing	Size/carton(mm)	G.W/carton(kgs)
S108-C	108	3	1roll/25m	355*355*115	15.8
S108-I	108	2	1roll/12.2m	225*225*123	6
S152-F	152.4	3	1roll/25m	360*360*160	21.5
S152-K	152.4	2			

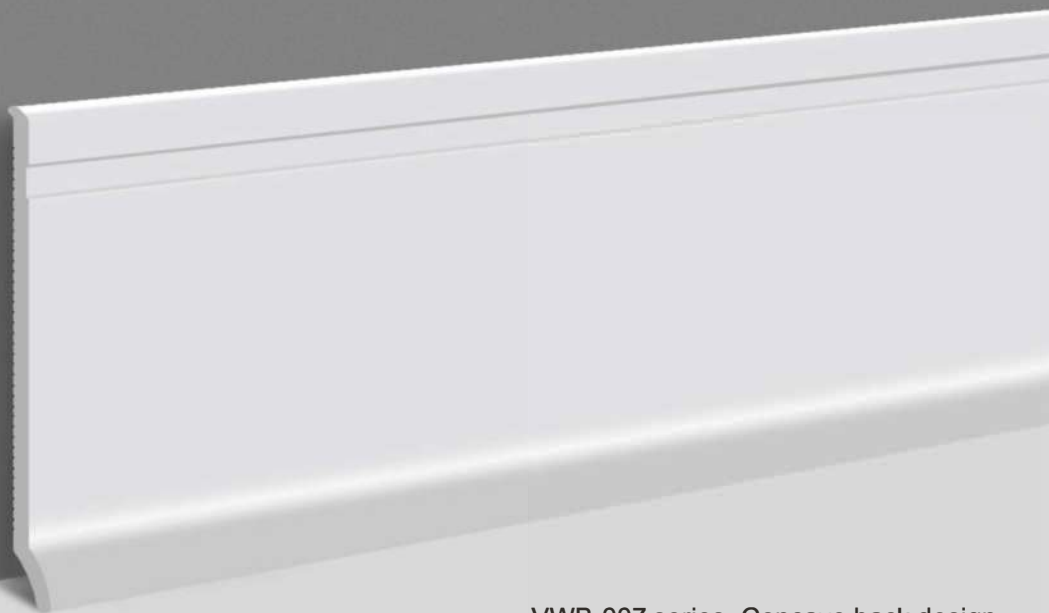
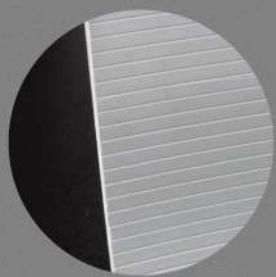

VWB-007 series- Concave back design

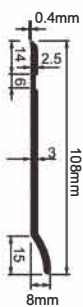
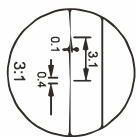

S108-D

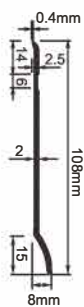

S108-F

Item No.	Hight(mm)	Thickness(mm)	Packing	Size/carton(mm)	G.W/carton(kgs)
S108-D	108	3	1roll/25m	355*355*115	15.8
S108-F	108	2	1roll/12.2m	225*225*123	6



VWB-008 series- Flat back, with soft strip

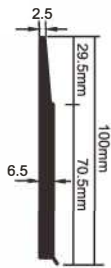

S100-S

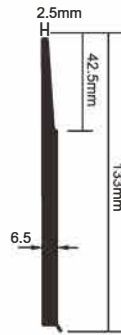

S133-C

Item No.	Hight(mm)	Thickness(mm)	Packing	Size/carton(mm)	G.W/carton(kgs)
S100-S	100	6.5	1roll/30.48m	560*560*108	32.2
S133-C	133	6.5		560*560*141	42.5

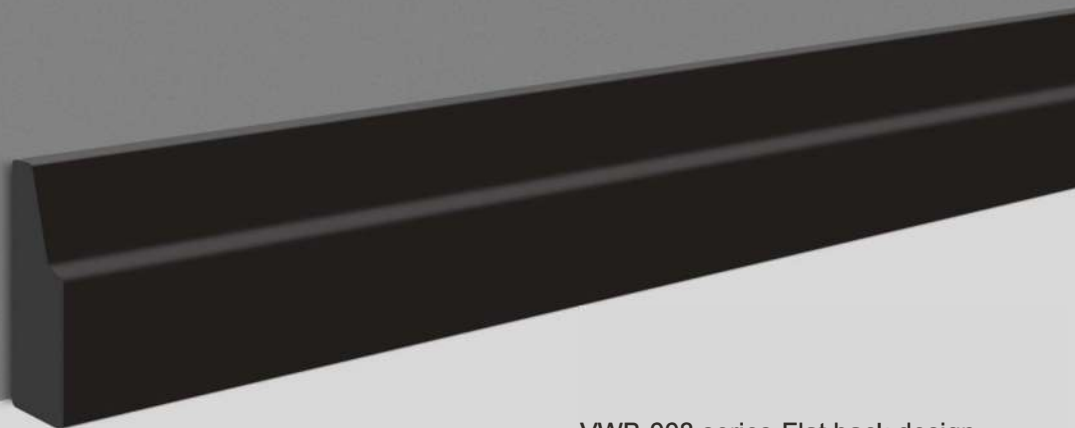

VWB-008 series-Flat back design

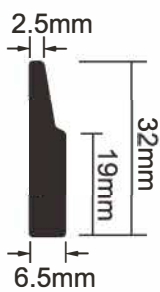

S32-B

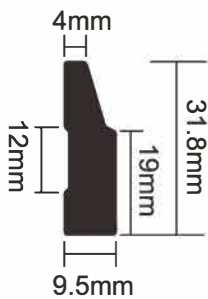

S32-D
(S-CG-32*10)

Item No.	Hight(mm)	Thickness(mm)	Packing	Size/carton(mm)	G.W/carton(kgs)
S32-B	32	6.5	30.48m/roll,2roll/carton	540*540*75	20.3
S32-D(S-CG-32*10)	32	9.5	100m/roll,1roll/carton	455*455*305	48



VWB-009 series-Flat back design



S32-A

Item No.	Hight(mm)	Thickness(mm)	Packing	Size/carton(mm)	G.W/carton(kgs)
S32-A	32	6.5	30.48m/roll,2roll/carton	540*540*75	18.2

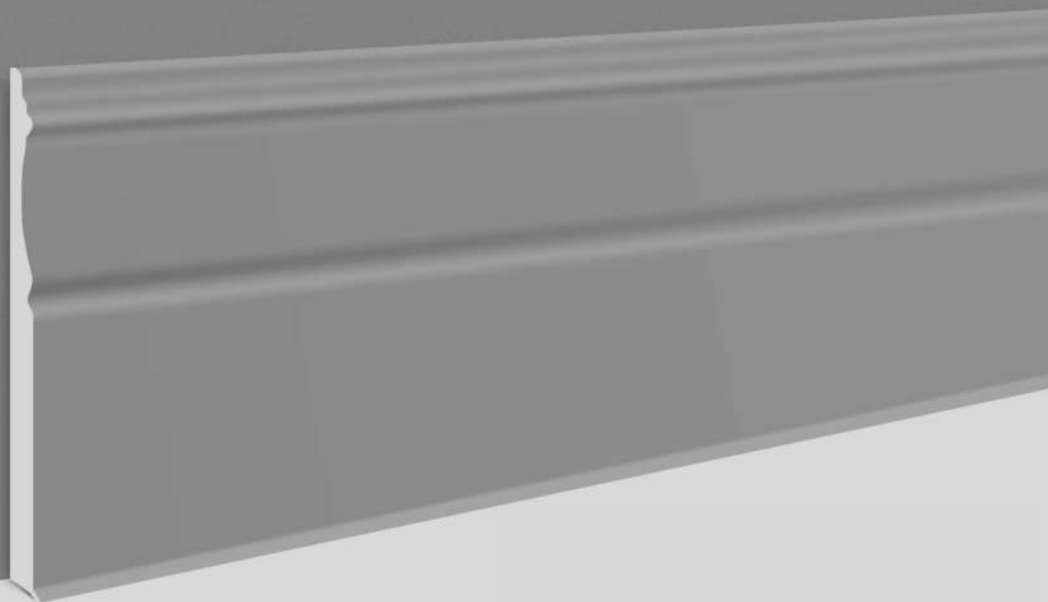

VWB-009 series- Flat back, with soft strip

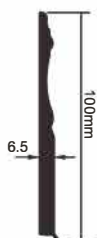

S100-R

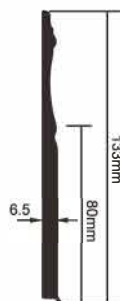

S133-B

Item No.	Hight(mm)	Thickness(mm)	Packing	Size/carton(mm)	G.W/carton(kgs)
S100-R	100	6.5	1roll/30.48m	560*560*108	30
S133-B	133	6.5		560*560*141	41

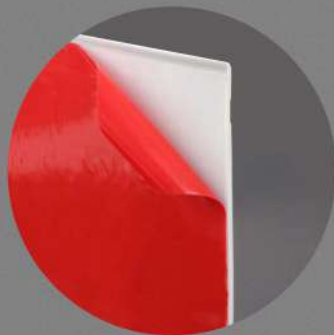

VWB-010 series-Flat back design



S98-I

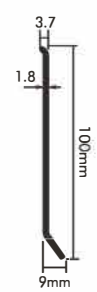

S100-V

Item No.	Hight(mm)	Thickness(mm)	Packing	Size/carton(mm)	G.W/carton(kgs)
S98-I	98	1.8	1roll/3m,12roll/carton	455*308*243	13
S100-V	100	1.8	1roll/6.1m	175*175*107	2.3



VWB-011 series- Concave back design

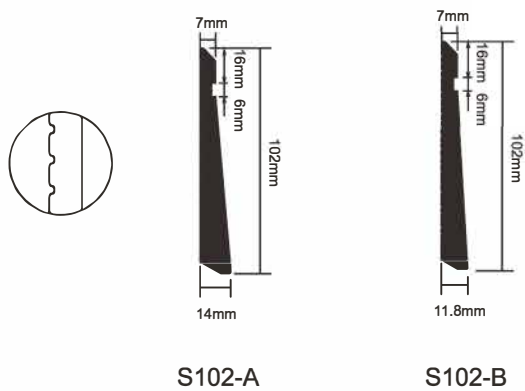

S102-A

S102-B

Item No.	Hight(mm)	Thickness(mm)	Packing	Size/carton(mm)	G.W/carton(kgs)
S102-A	102	14	1pcs/2.44m,6pcs/carton	2465*114*68	26.5
S102-B	102	11.8	1pcs/2.44m,8pcs/carton	2465*111*70	31.8

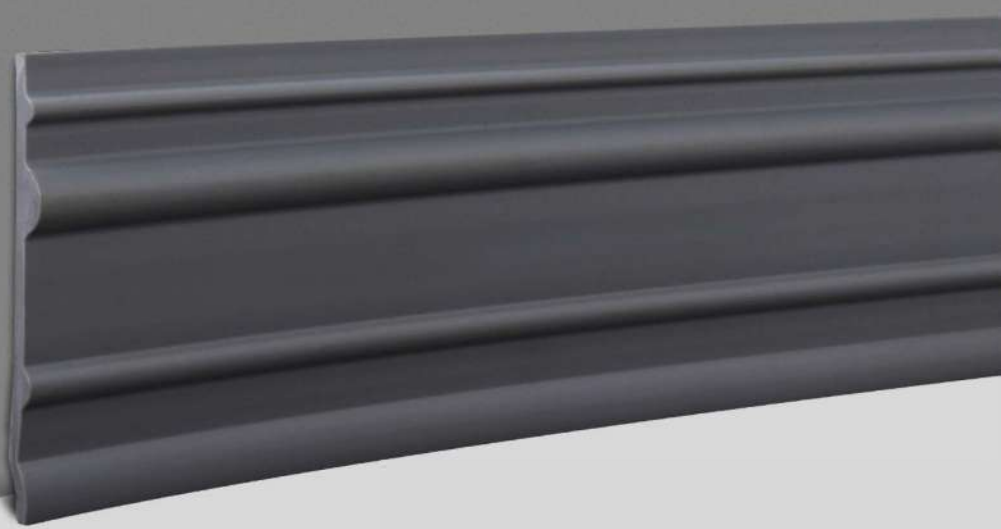
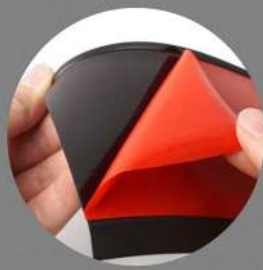

VWB-012 series-Flat back design

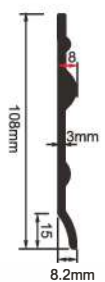

S108-E



S152-G

Item No.	Hight(mm)	Thickness(mm)	Packing	Size/carton(mm)	G.W/carton(kgs)
S108-E	108	3	1roll/15m	450*450*121	11.8
S152-G	152.4	3	1roll/15m	430*430*161	16



VWB-013 series- Concave back design

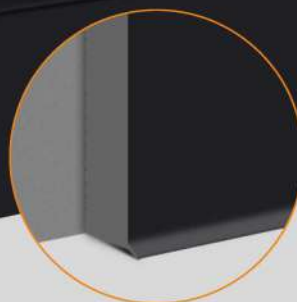

VWB-013 series- Concave, with soft strip

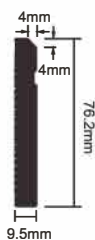
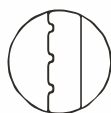

S76-A



S76-E

Item No.	Hight(mm)	Thickness(mm)	Packing	Size/carton(mm)	G.W/carton(kgs)
S76-A	76.2	9.5	1pcs/2.44m, 10pcs/carton	2465*159*51	32.5
S76-E	76.2	9.5	1pcs/2.44m, 10pcs/carton	2465*159*51	32.5



VWB-014 series-Flat back design

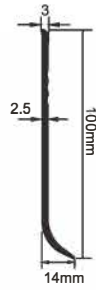

S100-Q

Item No.	Hight(mm)	Thickness(mm)	Packing	Size/carton(mm)	G.W/carton(kgs)
S100-Q	100	2.5	1roll/11m	225*225*112	5.1

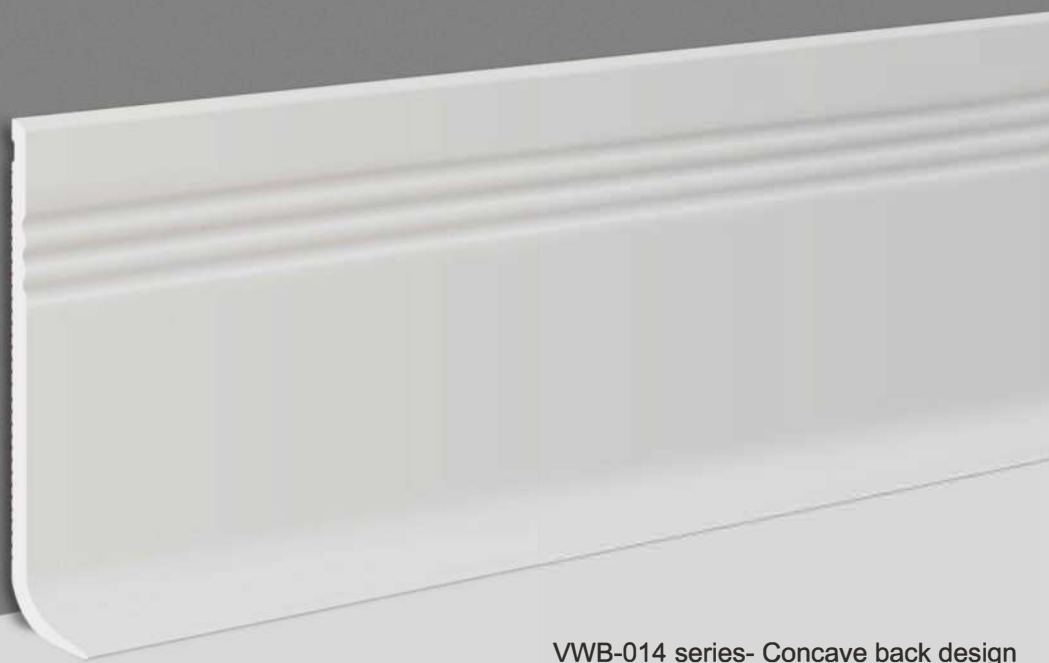
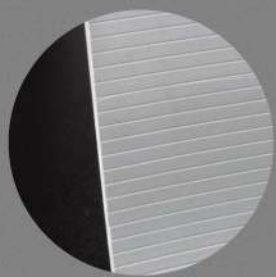

VWB-014 series- Concave back design

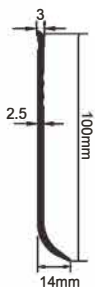
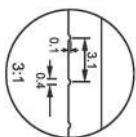

S100-P

Item No.	Hight(mm)	Thickness(mm)	Packing	Size/carton(mm)	G.W/carton(kgs)
S100-P	100	2.5	1roll/11m	225*225*112	5.1

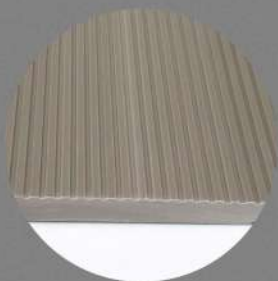

VWB-015 series- Concave back design

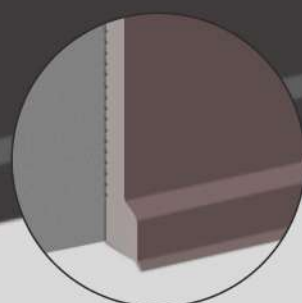

VWB-015 series- Concave, with soft strip

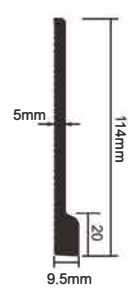

S114-C

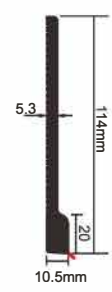

S114-F

Item No.	Hight(mm)	Thickness(mm)	Packing	Size/carton(mm)	G.W/carton(kgs)
S114-C	114	5	8pcs/ctn	2460*122*74	
S114-F	114	5.3	8pcs/ctn	2460*146*58	24.3

VWB series-Others

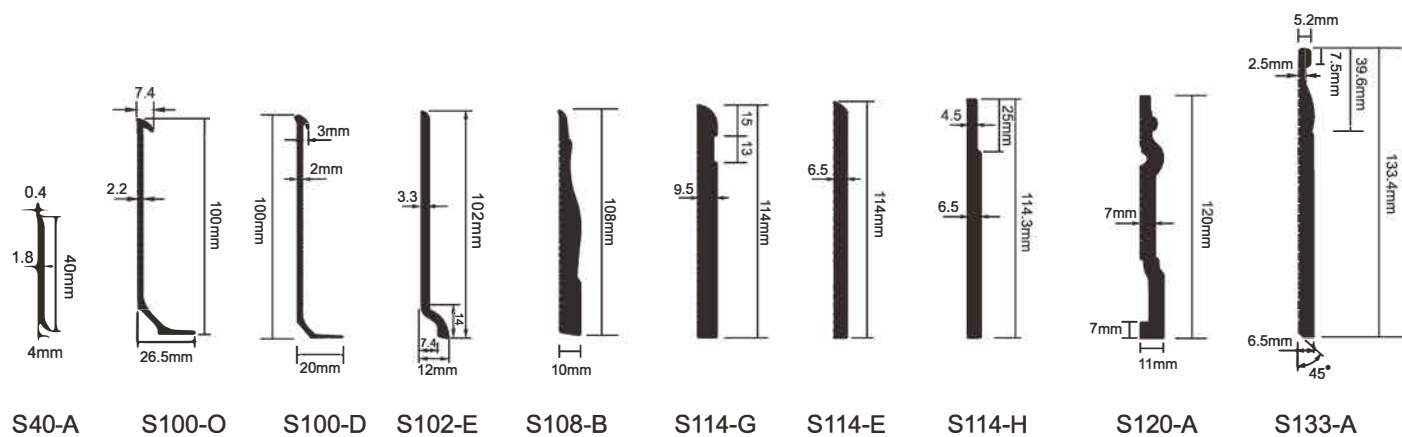

Item No.	Hight(mm)	Thickness(mm)	Packing	Size/carton(mm)	G.W/carton(kgs)
S40-A	40	1.8			
S100-O	100	2.2	1pcs/2.5m,20pcs/ctn	2515*140*122	24
S100-D	100	2	1roll/50m	640*640*118	23
S102-E	102	3.3	1roll/25m	437*437*114	20.3
S108-B	108	10	1pcs/2.44m,8pcs/ctn	2465*184*54	31.3
S114-G	114	9.5	1pcs/2.44m,6pcs/ctn	2465*122*65	28.4
S114-E	120	7	1pcs/2.44m,10pcs/ctn	2465*122*77	32.4
S114-H	114.3	6.5	1pcs/2.44m,8pcs/ctn	2465*122*59	25.8
S120-A	120	7	1pcs/2.44m,8pcs/ctn	2465*130*86	31.7
S133-A	133.4	6.5	1pcs/2.44m,10pcs/ctn	2465*140*73	35.8

Flexible PVC Decorative Profile (Vinyl decorative profile)



- **Vinyl Floor Accessories**
- **Vinyl Stair Accessories**
- **Vinyl Corner Guard**
- **Other Vinyl Decorative Trim**

Subfloor leveler

Key Features:

- ✓ Tapered Design
- ✓ Instant Installation
- ✓ Foot Traffic Ready
- ✓ Flexible & Durable

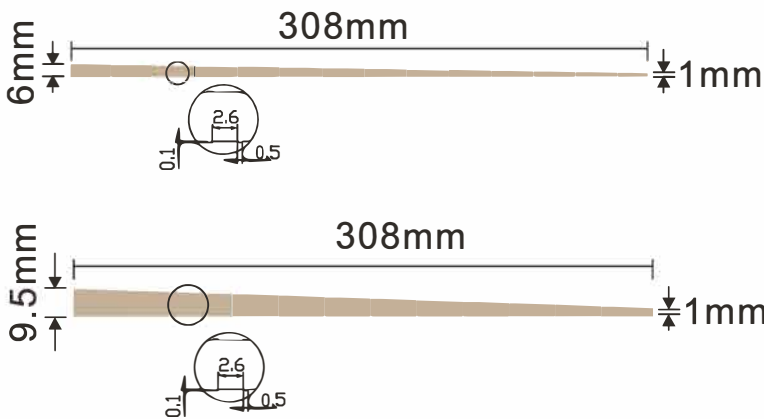

S-SF-308

Length: 1.22m/pcs
Qty in carton: 10pcs/ctn
Carton Size: 1225*319*42mm
Gross Weight: 24.5kgs

S-SF-308-A

Length: 1.22m/pcs
Qty in carton: 8pcs/ctn
Carton Size: 1225*318*51mm
Gross Weight: 29.5kgs



Vinyl Floor Accessories

Vinyl T-moulding 1



Fireproof



Waterproof



Easy to Install



Eco-Friendly



Formaldehyde



Free No Heavy Metal



S-YP-38

Packing 48m(6m/roll)
Size/carton 456*456*94mm
G.W/carton 8.7kgs

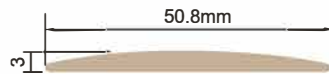

S-YP-50

Packing 48m(6m/roll)
Size/carton 416*416*115mm
G.W/carton 11.6kgs



Vinyl T-moulding 2

S-P37

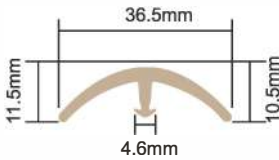

Packing 30pcs/carton
Size/carton 2715*116*77mm
G.W/carton 20kgs



Vinyl Reducer 1

S-YG-38

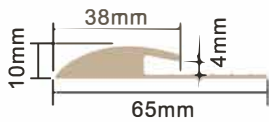

Packing 20pcs/carton,1.22m/piece
Size/carton 1230*192*67mm
G.W/carton 12.8kgs

S-YG-34

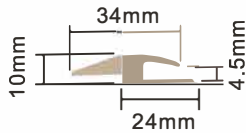

Packing 30pcs/carton,1.22m/piece
Size/carton 1230*182*64mm
G.W/carton 11kgs

S-YG-23

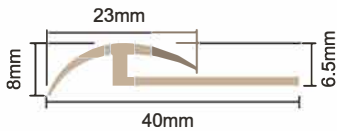

Packing 50pcs/carton,2.5m/piece
Size/carton 2515*168*52mm
G.W/carton 18.7kgs



Vinyl Reducer 2

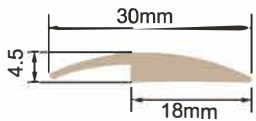

S-YG-30

Packing 6m/roll,16rolls/ctn
Size/carton 430*430*140mm
G.W/carton 7.7kgs

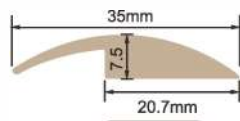

S-YG-35

Packing 6m/roll,8rolls/ctn
Size/carton 576*576*92mm
G.W/carton 13.5kgs

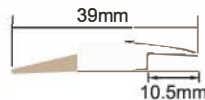

S-YG-39



Vinyl Stair Accessories

Vinyl Stair Edge Protector 1



Easy to Clean



Waterproof



Fireproof



Easy to Install



No Heavy Metal



Formaldehyde Free

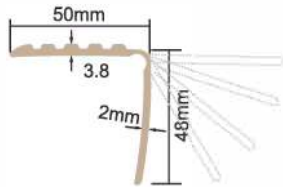

S-SN-50*48

Packing 15m/roll, 1roll/ctn
 Size/carton 310*310*102mm
 G.W/carton 6.5kgs

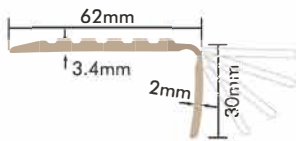

S-SN-62*30

Packing
 Size/carton
 G.W/carton



Vinyl Stair Edge Protector 2

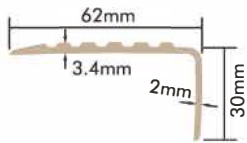

S-CG-62*30

Packing 20pcs/ctn, 2m/piece
 Size/carton 2015*136*70mm
 G.W/carton 16.3kgs

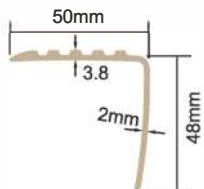

S-CG-50*48

Packing 20pcs/carton, 2.7m/piece
 Size/carton 2715*142*61mm
 G.W/carton 24.3kgs



Vinyl Corner Guard

Vinyl corner Guard 1

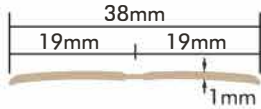

S-UA-19*19

Packing	30m/roll, 1rolls/box
Size/carton	280*280*44mm
G.W/carton	2.4kgs



S-UA-30*30

Packing	30m/roll, 1rolls/box
Size/carton	350*350*71mm
G.W/carton	8.3kgs

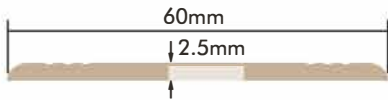

S-UA-30*30-A

Packing	30m/roll, 1rolls/box
Size/carton	350*350*71mm
G.W/carton	8.3kgs



Vinyl corner Guard 2

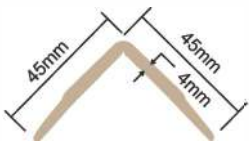

S-CG-45*45

Packing	20pcs/ctn, 2.7m/piece
Size/carton	2715*134*86mm
G.W/carton	29.7kgs

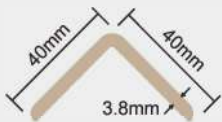

S-CG-40*40(A)

Packing	20pcs/ctn, 2.5m/piece
Size/carton	2715*123*92mm
G.W/carton	26kgs

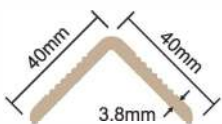

S-CG-40*40

Packing	30pcs/ctn, 2.44m/piece
Size/carton	2455*206*61mm
G.W/carton	42.6kgs

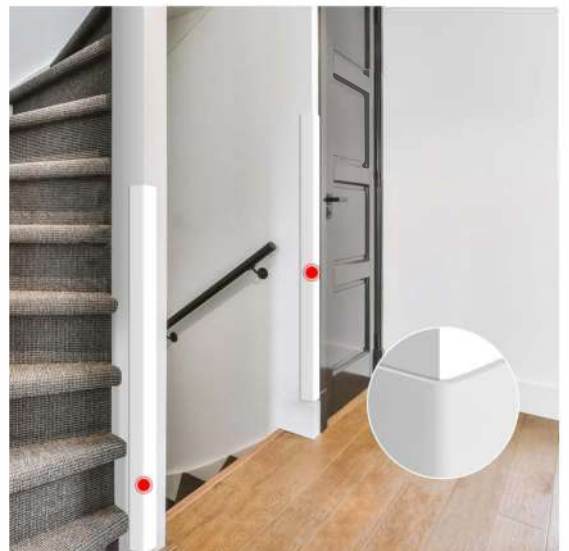

Other Vinyl Decorative Trim

Vinyl Caulk Strip

S-C16*16

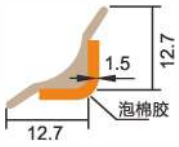

Packing 12.2m/roll, 8roll/carton
 Size/carton 275*275*201mm
 G.W/carton 8.5kgs

S-C22*22

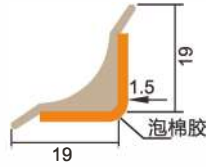

Packing 6.1m/roll, 6roll/carton
 Size/carton 275*275*213mm
 G.W/carton 6.4kgs



Vinyl Quarter Round Trim

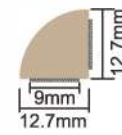

S-QR-13

Packing 6.1m/roll
 Size/carton 260*260*55mm
 G.W/carton 1.5kgs

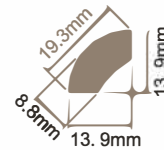

S-QR-14

Packing 12m/roll, 8roll/carton
 Size/carton 420*420*170mm
 G.W/carton 23.5kgs

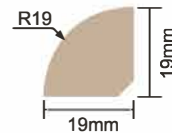

S-QR-19

Packing 20pcs/carton
 Size/carton 345*345*215mm
 G.W/carton 17.5kgs

Vinyl Wall Corner Trim

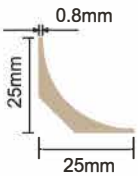

S-C25

Packing 40pcs/ctn, 2.5m/piece
 Size/carton 2515*146*58mm
 G.W/carton 24.5kgs

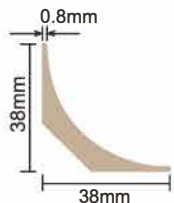

S-38*38

Packing 20pcs/ctn, 2.5m/piece
 Size/carton 2515*141*63mm
 G.W/carton 22.5kgs

