



- Size: 900×700×30mm
900×900×30mm
1000×700×30mm
1000×800×30mm
1000×900×30mm
1200×700×30mm
1200×800×30mm
1200×900×30mm
1400×700×30mm
1400×800×30mm
1400×900×30mm
1600×800×30mm
1600×900×30mm





ELEGANCE AND INTELLECTUALITY ARE WELL INTERPRETED HERE, WITHOUT DELIBERATE CARVING AND MODIFICATION, WITHOUT TOO MUCH GORGEOUSNESS AND COLOR, WITH PURE DESIGN TO BRING SENSORY SHOCK.

ULTIMATE
BEAUTY SEEKS
SIMPLICITY.



simple power, simple shape, elegant construction. extremely pure and seemingly ordinary, the shape strictly adheres to the golden ratio, exuding a subtle but indisputable simplicity of beauty.

CUSTOMIZED SERVICES CAN BE CUSTOMIZED ACCORDING TO THE DIFFERENT NEEDS OF CUSTOMERS TO CREATE EXCLUSIVE DESIGN.

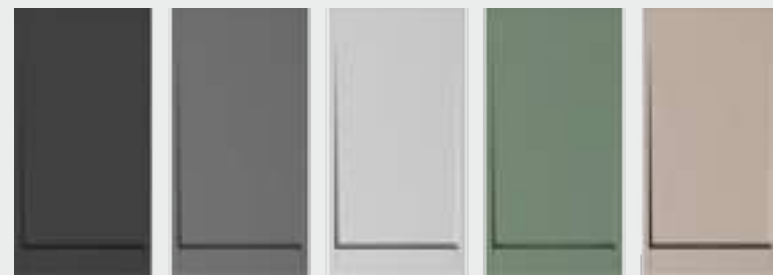
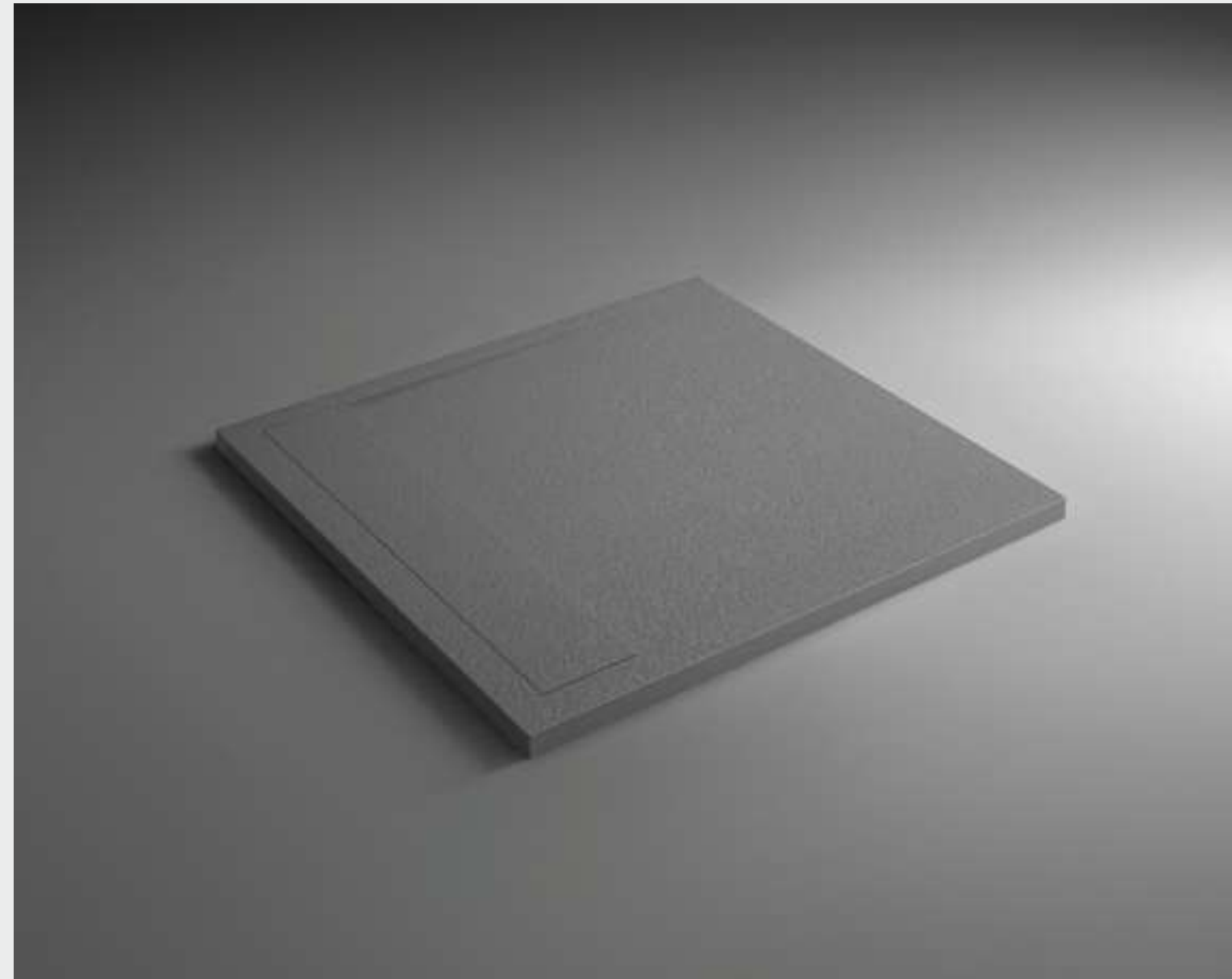
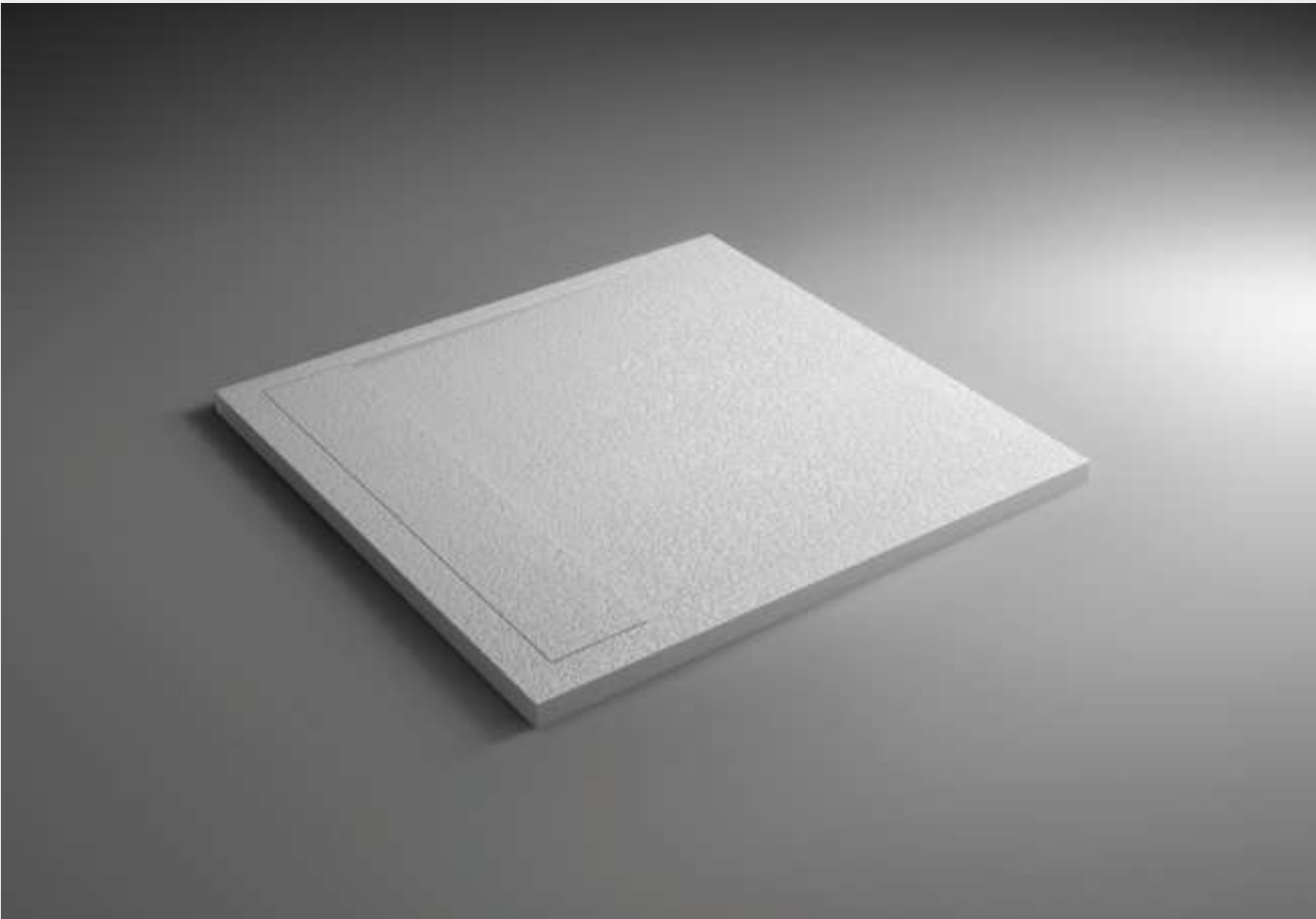

Size: 900×700×30mm	1200×900×30mm
900×900×30mm	1400×700×30mm
1000×700×30mm	1400×800×30mm
1000×800×30mm	1400×900×30mm
1000×900×30mm	1600×800×30mm
1200×700×30mm	1600×900×30mm
1200×800×30mm	



Size: 48*32in
48*36in
60*32in
60*36in

**DIVE INTO THE DEPTHS
OF THE OCEAN AND BUILD
THE ART OF LIVING.**







Size: 900×700×30mm
 900×900×30mm
 1000×700×30mm
 1000×800×30mm
 1000×900×30mm
 1200×700×30mm
 1200×800×30mm
 1200×900×30mm
 1400×700×30mm
 1400×800×30mm
 1400×900×30mm
 1600×800×30mm
 1600×900×30mm

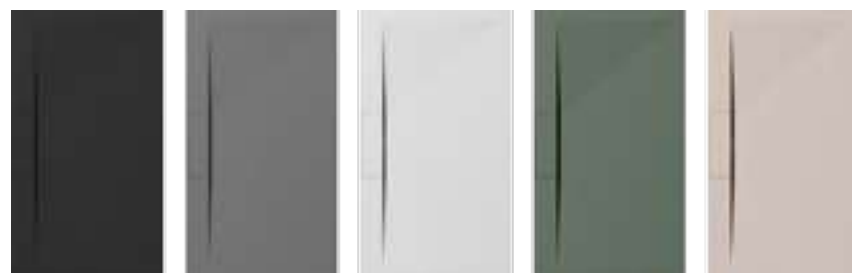

Size: 900×700×30mm
 900×900×30mm
 1000×700×30mm
 1000×800×30mm
 1000×900×30mm
 1200×700×30mm
 1200×800×30mm
 1200×900×30mm
 1400×700×30mm
 1400×800×30mm
 1400×900×30mm
 1600×800×30mm
 1600×900×30mm



MAN IS A SENSORY CREATURE. MILLIONS OF TACTILE SENSORS LINE THE HUMAN SKIN. TACTILE CONTACT IS MORE POWERFUL THAN VISUAL OR AUDITORY STIMULI. THE USE OF NATURAL MATERIALS IS ESSENTIAL.

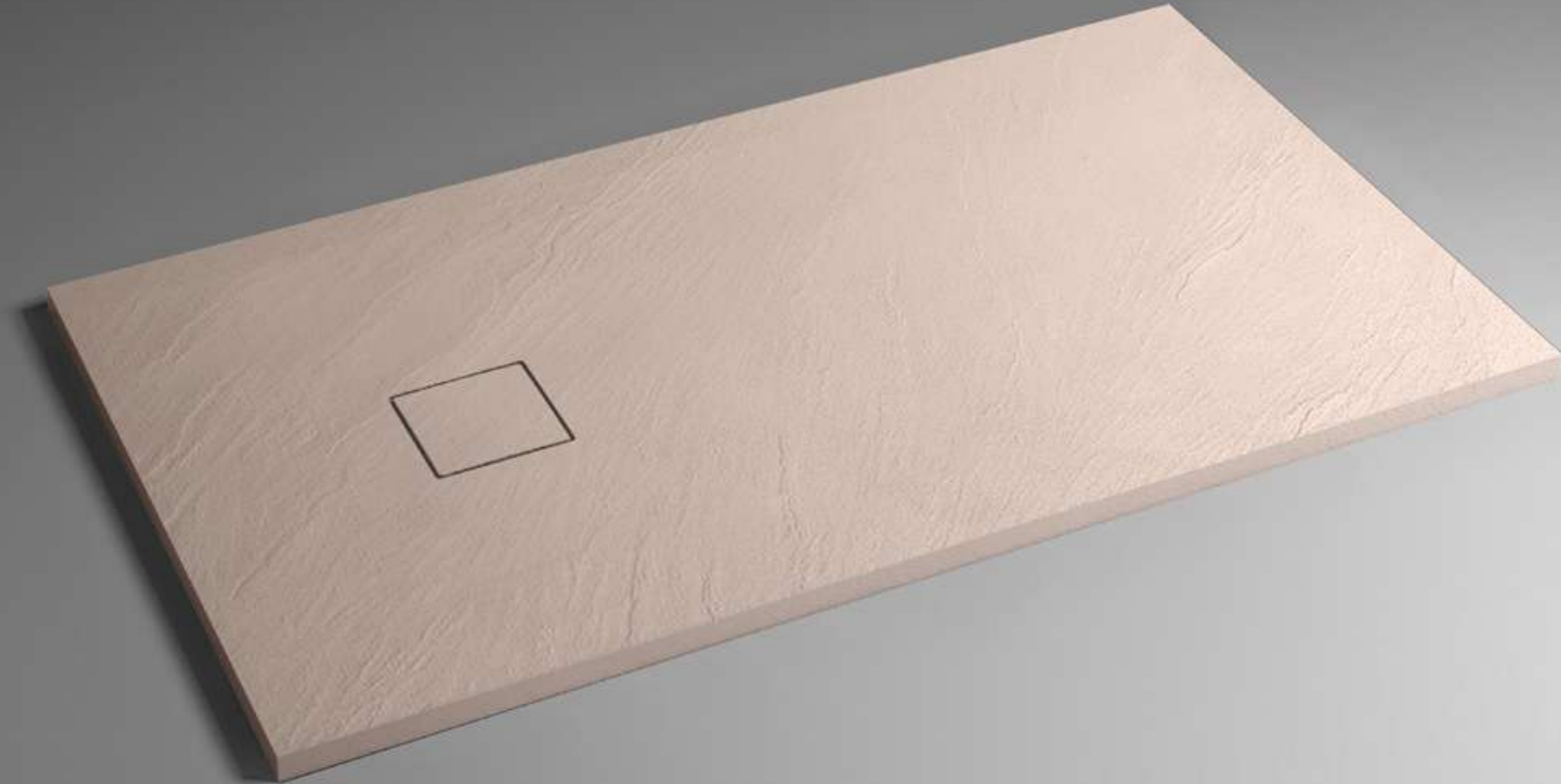

Size: 900×700×30mm
900×900×30mm
1000×700×30mm
1000×800×30mm
1000×900×30mm
1200×700×30mm
1200×800×30mm
1200×900×30mm
1400×700×30mm
1400×800×30mm
1400×900×30mm
1600×800×30mm
1600×900×30mm



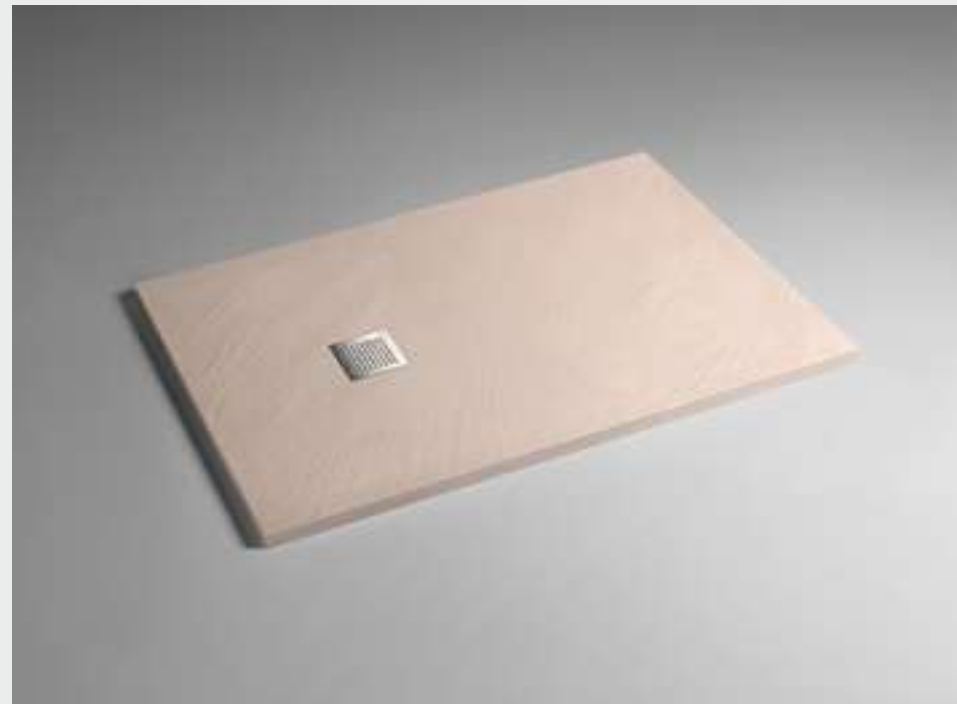

Size: 800×800×35mm
 900×900×35mm
 1000×800×35mm
 1200×800×35mm

THE SQUARE AND ROUND DESIGN IS PERFECTLY PROPORTIONED, SYMBOLIZING ABSOLUTE BEAUTY. SIMPLE STYLING FITS ANY SPACE. THE FLAT ROUND OR SQUARE APPEARANCE INTERPRETS PURE DESIGN. THE TIMELESS CLASSIC SHAPE IS SUITABLE FOR ALL BATHROOM SPACES.

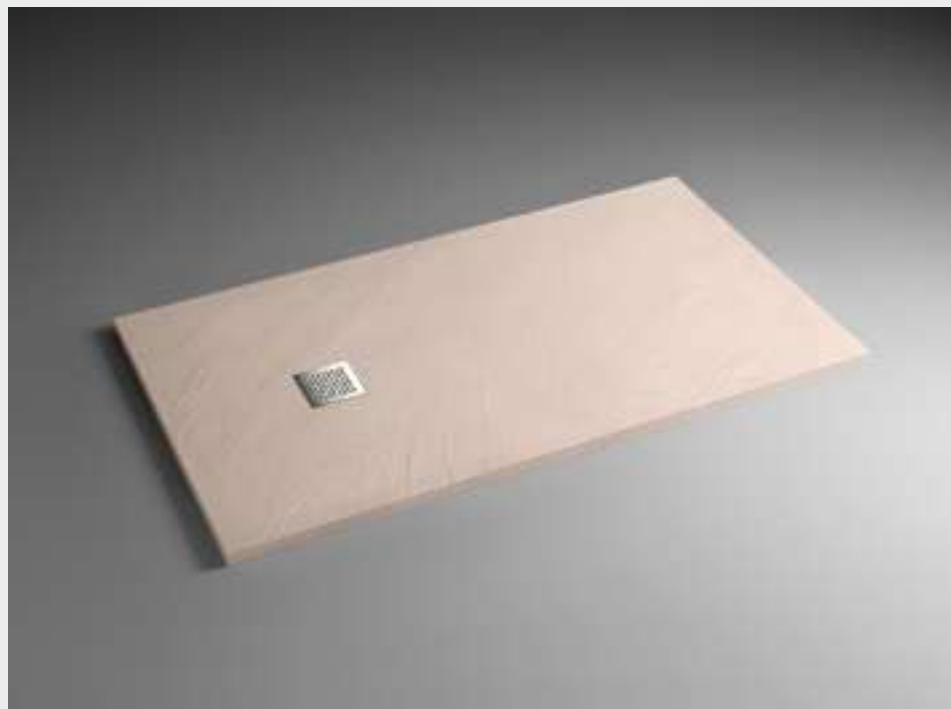
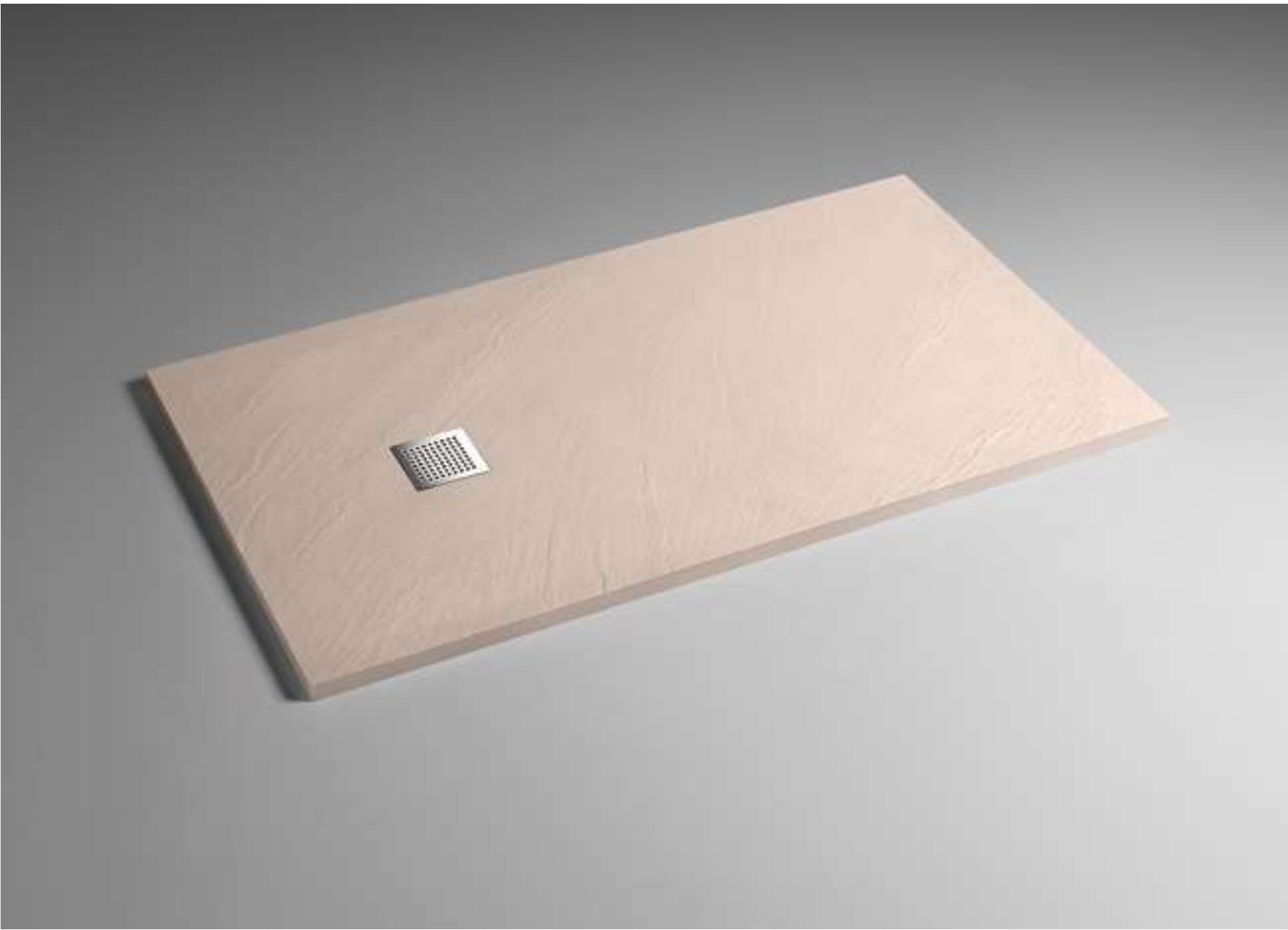

Size: 900×900×30mm
 1000×700×30mm
 1000×800×30mm
 1200×700×30mm
 1200×800×30mm
 1200×900×30mm
 1400×900×30mm

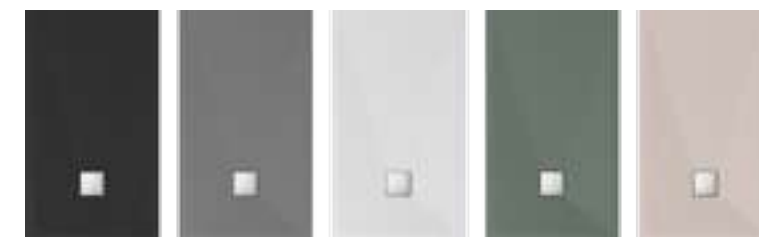
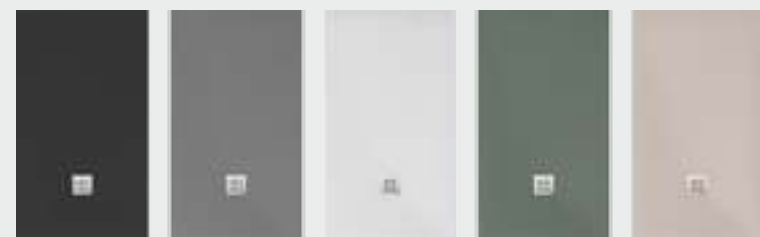

Size: 800×800×35mm
 900×900×35mm
 1000×800×35mm
 1200×800×35mm

**WITH SIMPLE BLOCK
SURFACE AND LINE DESIGN.**





MAN IS A SENSORY CREATURE. MILLIONS OF TACTILE SENSORS LINE THE HUMAN SKIN. TACTILE CONTACT IS MORE POWERFUL THAN VISUAL OR AUDITORY STIMULI. THE USE OF NATURAL MATERIALS IS ESSENTIAL.

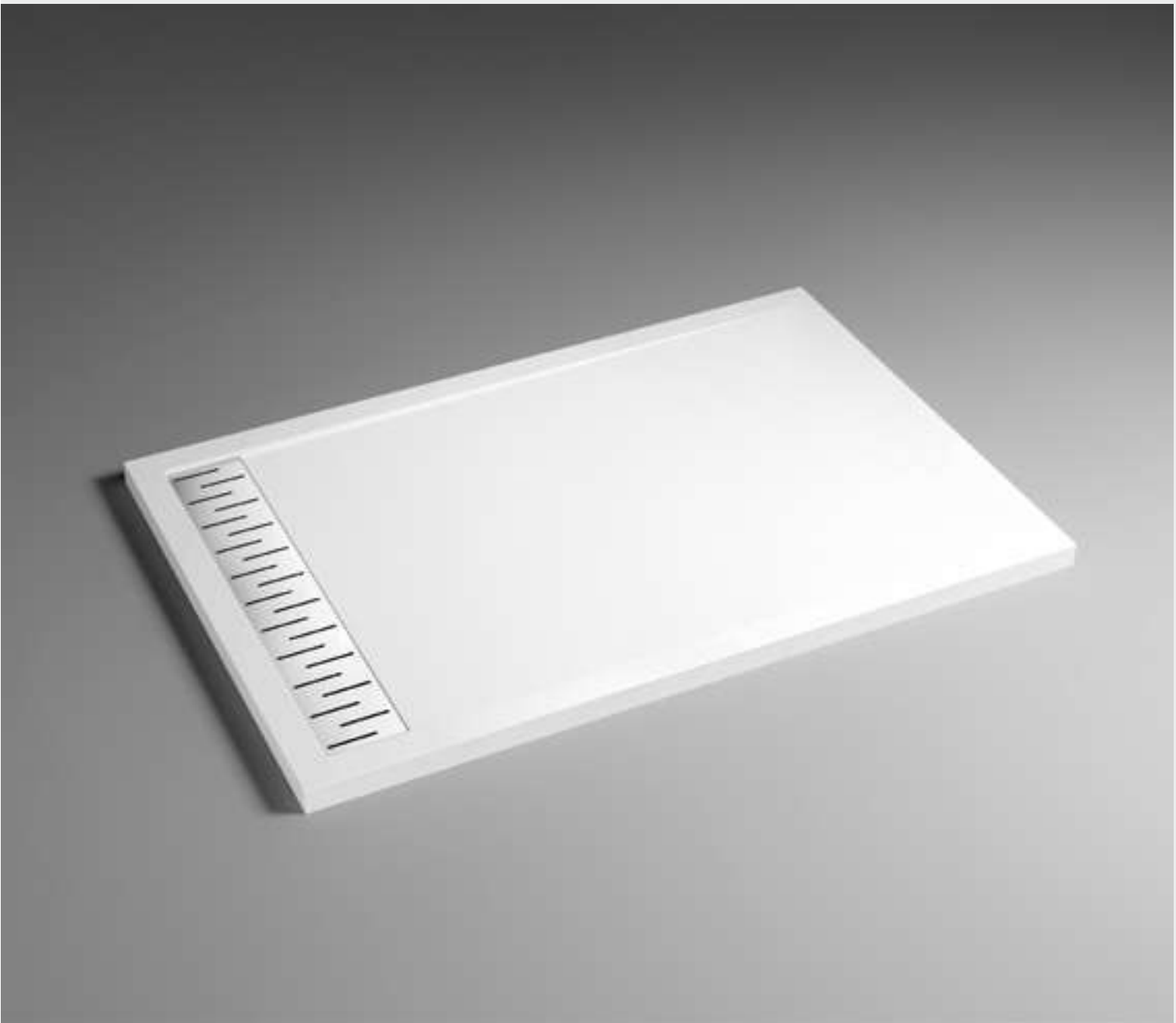

Size: 900×900×40mm
1200×800×40mm

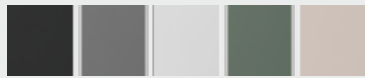

Size: 900×900×40mm
1200×800×40mm



An aerial, high-angle photograph of a dark, sandy beach meeting the ocean. The waves are breaking along the shoreline, creating white foam that contrasts with the dark sand and water. The perspective is from the top left, looking down and along the coast towards the bottom right.

THE MOVEMENT OF
THE OCEAN AND NATURAL
ELEMENTS.



Size: 900×900×40mm
1200×800×40mm



SOLID, RELIABLE AND DURABLE.
TAILOR MADE - BRING FASHION BACK TO THE BATHROOM.

ADDS QUALITY AND BEAUTY TO THE BATHROOM.

Size: 1900×900×40mm



Glass color

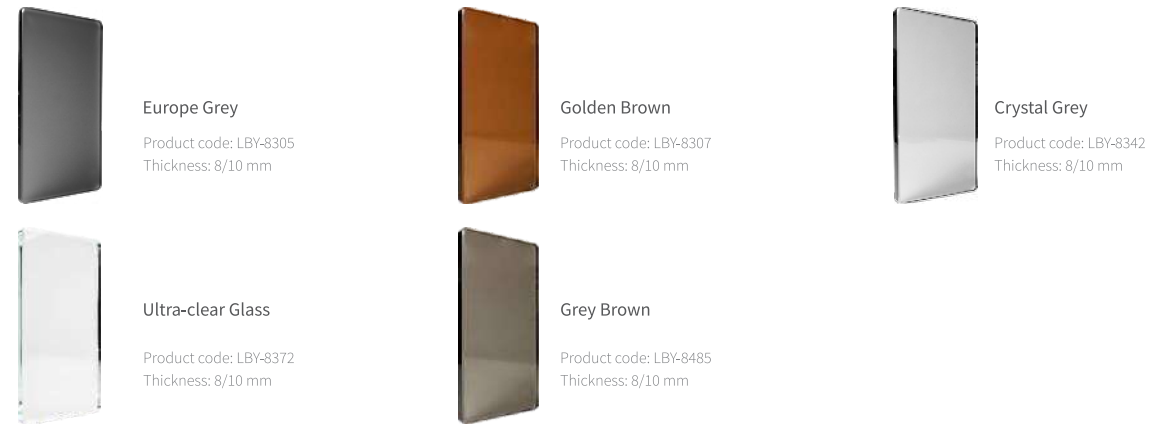

Laminated glass (Applicable to full frame shower room only)

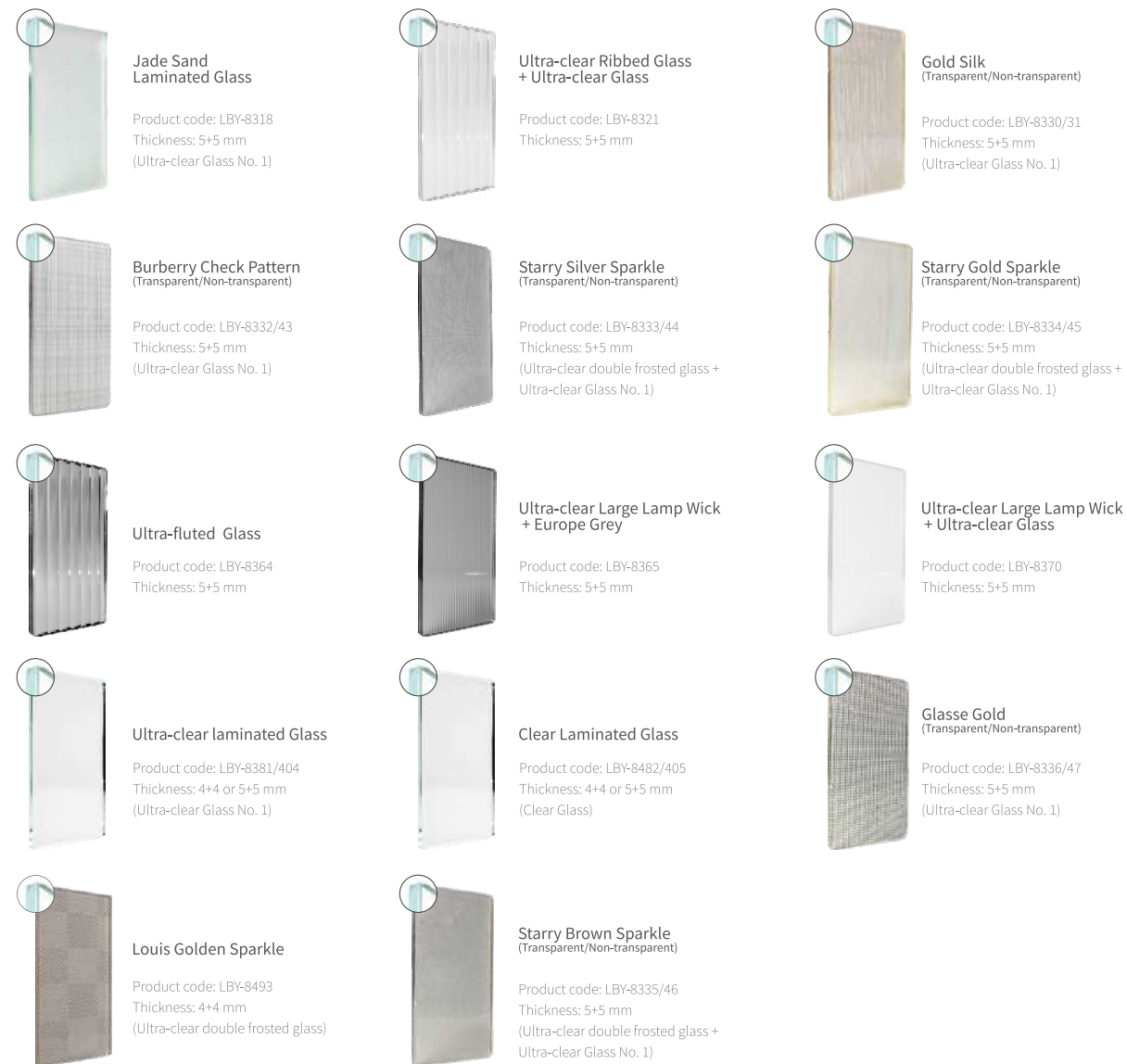

Cragglass



Patterned glass

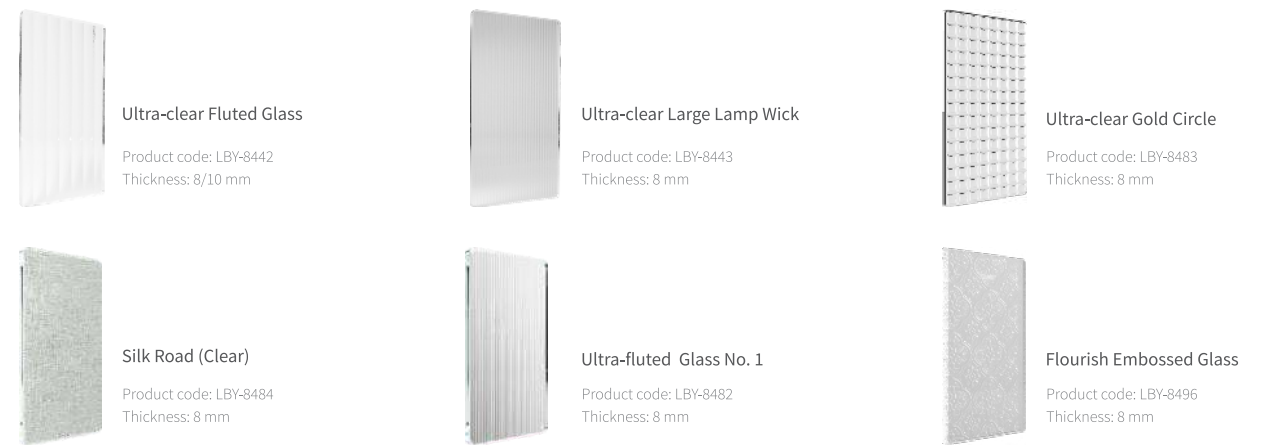

Colored laminated glass (Applicable to full frame shower room only)

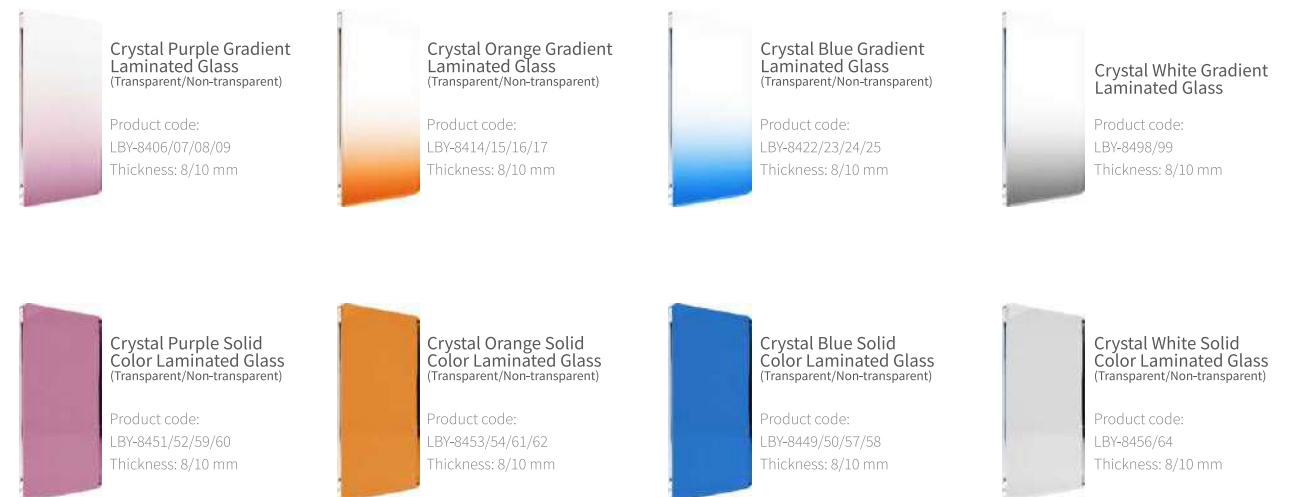

Shower door handles

Shower door handles

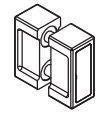

Product code: LS-8152
Size: 45 x 20
Material: Zinc

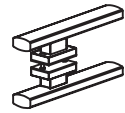

Product code: LS-8073
Size : Hole distance 57
Material: Stainless steel

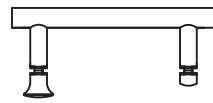

Product code: LS-8015
Size: Ø19(Hole distance 144)
Material: Stainless steel

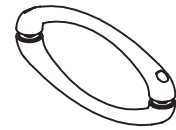

Product code: LS-8121
Size: Hole distance 144
Material: ABS

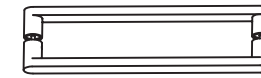

Product code: LS-8112
Size: 25x13(Hole distance 300)
Material: Stainless steel

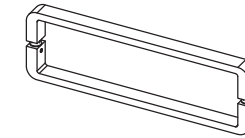

Product code: LS-8070
Size: 11x22(Hole distance 300)
Material: Zinc

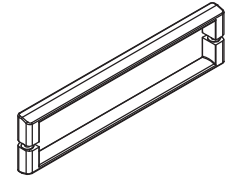

Product code: LS-8110
Size: 300/320
Material: Stainless steel

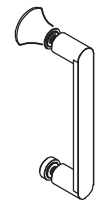

Product code: LS-8211
Size: Hole distance 145
Material: Zinc

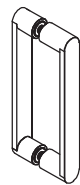

Product code: LS-8210
Size: Hole distance 145
Material: Zinc

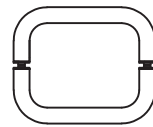

Product code: LS-8069
Size: Ø19(Hole distance 150)
Material: Stainless steel

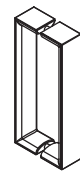

Product code: LS-8151
Size: 170
Material: Zinc



Product code: LS-8063
Size: Hole distance 380
Material: Zinc

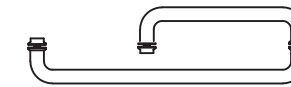

Product code: LS-8005
Size: 300* (400/500)
Material: Stainless steel

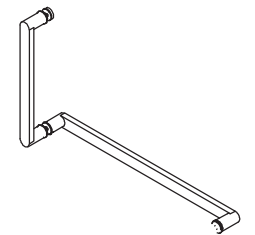

Product code: LS-8157
Size: 450/250
Material: SUS304

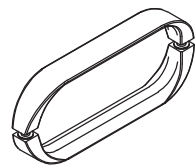

Product code: LS-8164
Size: Hole distance 200
Material: Zinc

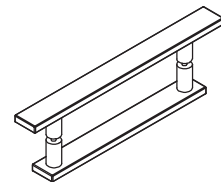

Product code: LS-8129
Size: 225/300
Material: SUS304

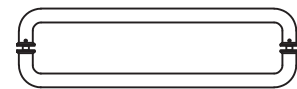

Product code: LS-8001
Size: Ø25(Hole distance 275/375/475)
Material: Stainless steel

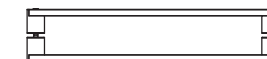

Product code: LS-8047
Size: Hole distance 475 (Can be customized)
Material: Zinc + Aluminum

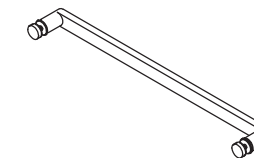

Product code: LS-8111
Size: Hole distance 400/500
Material: SUS304

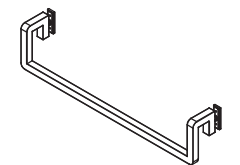

Product code: LS-8217
Size: Hole distance 450/550/650
Material: SUS304



FRAME MATERIAL: Aluminium frame

FRAME COLORS



Width B	Adjustment min-max B	Door opening C
1000	960-1000	370
1100	1060-1100	420
1200	1160-1200	470
1400	1360-1400	570
1500	1460-1500	570
1600	1560-1600	570
1700	1660-1700	570

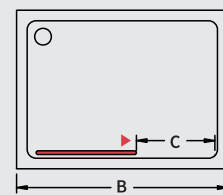

- 6 mm** GLASS THICKNESS
- HEIGHT 2000MM**
- 20 mm** PRODUCT ADJUSTMENT
- REVERSIBLE FOR LEFT OR RIGHT**
- ALL SCREWS ARE HIDDEN**
- FAST INSTALLATION**

*Other handles are available. For more information, please see page 13.



Width B	Adjustment min-max B	Door opening C
700	680-700	/
760	740-760	
800	780-800	
900	880-900	
1000	980-1000	

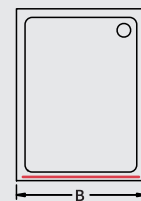

Width B1/B2	Adjustment min-max B	Door opening C
800/800	780-800	420
900/900	880-900	490
1000/1000	980-1000	560

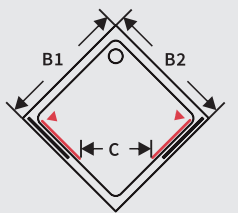

Impact block



Width B1/B2	Adjustment min-max B	Door opening C
760/900	740-760/880-900	400
800/800	780-800	415
900/900	880-900	470
1000/1000	980-1000	470
800/1000	780-800/980-1000	415
800/1200	780-800/1180-1200	415
900/1200	880-900/1180-1200	470

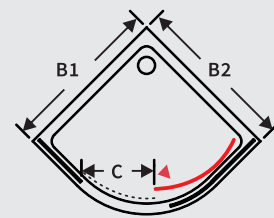

Width B1/B2	Adjustment min-max B	Door opening C
800/800	780-800	425
900/900	880-900	545
1000/1000	980-1000	545

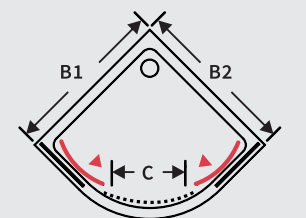



Width B	Adjustment min-max B	Door opening C
760	730-760	485
800	770-800	525
900	870-900	625
1000	970-1000	725

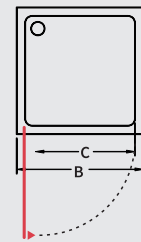

Width B	Adjustment min-max B	Door opening C
700	680-700	/
760	740-760	
800	780-800	
900	880-900	
1000	980-1000	

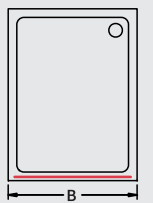



Width B	Adjustment min-max B	Door opening C
760	730-760	580
800	770-800	620
900	870-900	720
1000	970-1000	820

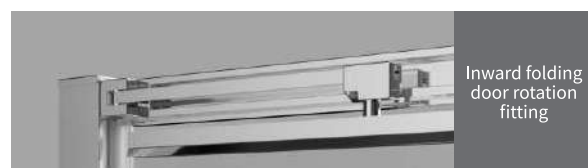

Inward folding door rotation fitting

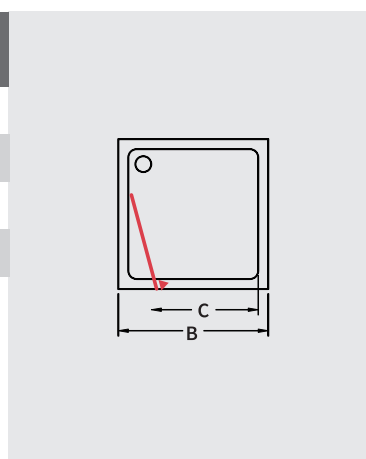

Width B	Adjustment min-max B	Door opening C
700	680-700	/
760	740-760	
800	780-800	
900	880-900	
1000	980-1000	

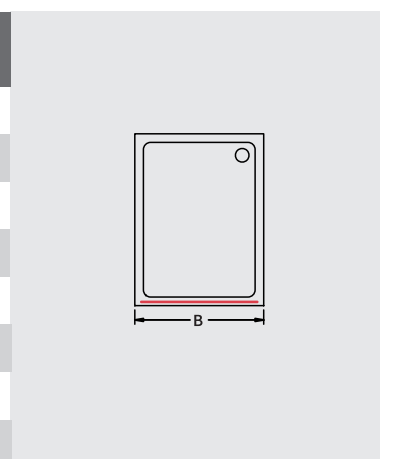



Width B	Adjustment min-max B	Door opening C
760	730-760	485
800	770-800	525
900	870-900	625
1000	970-1000	725

Width B	Adjustment min-max B	Door opening C
700	680-700	/
760	740-760	
800	780-800	
900	880-900	
1000	980-1000	



Width B	Adjustment min-max B	Door opening C
760	730-760	525
800	770-800	565
900	870-900	665
1000	970-1000	765

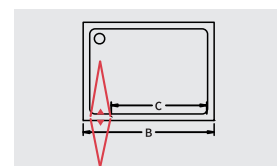

Width B	Adjustment min-max B	Door opening C
700	680-700	/
760	740-760	
800	780-800	
900	880-900	
1000	980-1000	

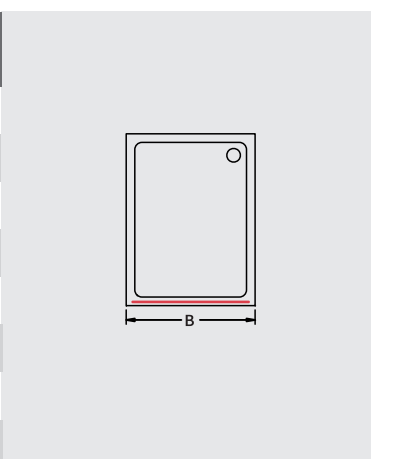



FRAME MATERIAL: Aluminium frame

FRAME COLORS

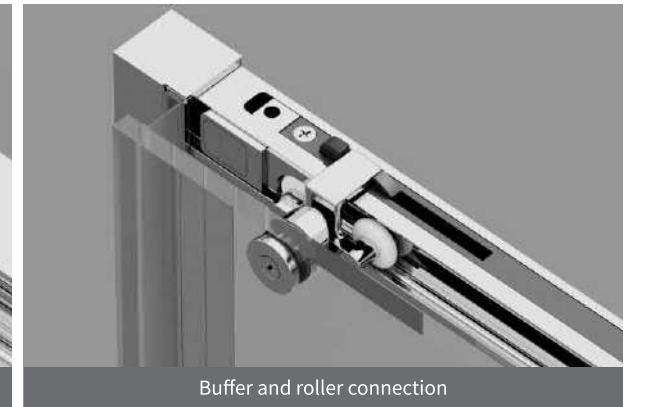
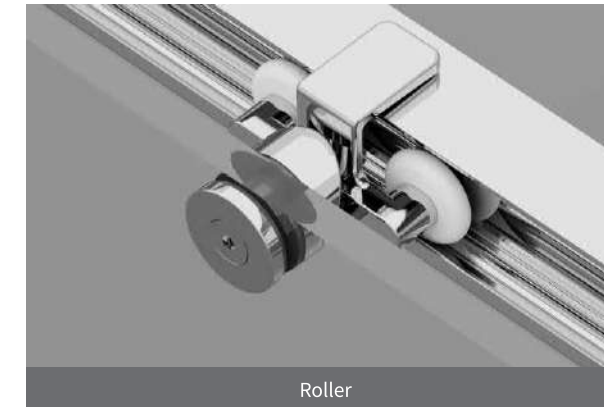
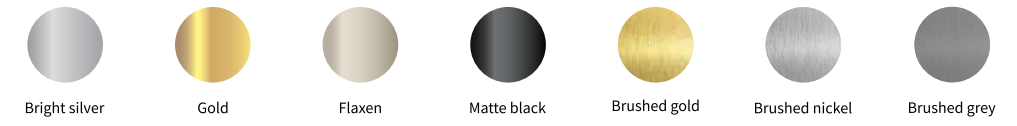

- 

8
mm
GLASS
THICKNESS
- 

HEIGHT
2000MM
- 

10
mm
PRODUCT
ADJUSTMENT
- 

REVERSIBLE FOR
LEFT OR RIGHT
- 

ALL SCREWS
ARE HIDDEN
- 

FAST
INSTALLATION

*Other handles are available. For more information, please see page 13.



Width B	Adjustment min-max B	Door opening C
1000	980-1000	375
1100	1080-1100	425
1200	1180-1200	475
1400	1380-1400	575
1500	1480-1500	575
1600	1580-1600	575
1700	1680-1700	575

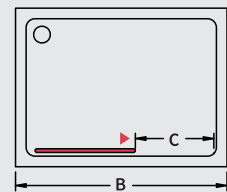

Width B	Adjustment min-max B	Door opening C
700	680-690	
760	740-750	
800	780-790	
900	980-990	

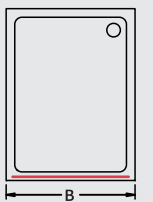



Width B1/B2	Adjustment min-max B	Door opening C
800/800	780-790	387
900/900	880-890	457
1000/1000	980-990	457

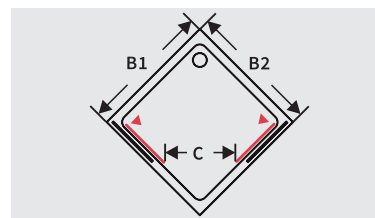

Width B1/B2	Adjustment min-max B	Door opening C
800/800	780-790	388
900/900	880-890	438
1000/1000	980-990	438

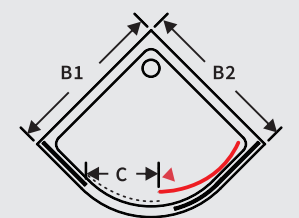

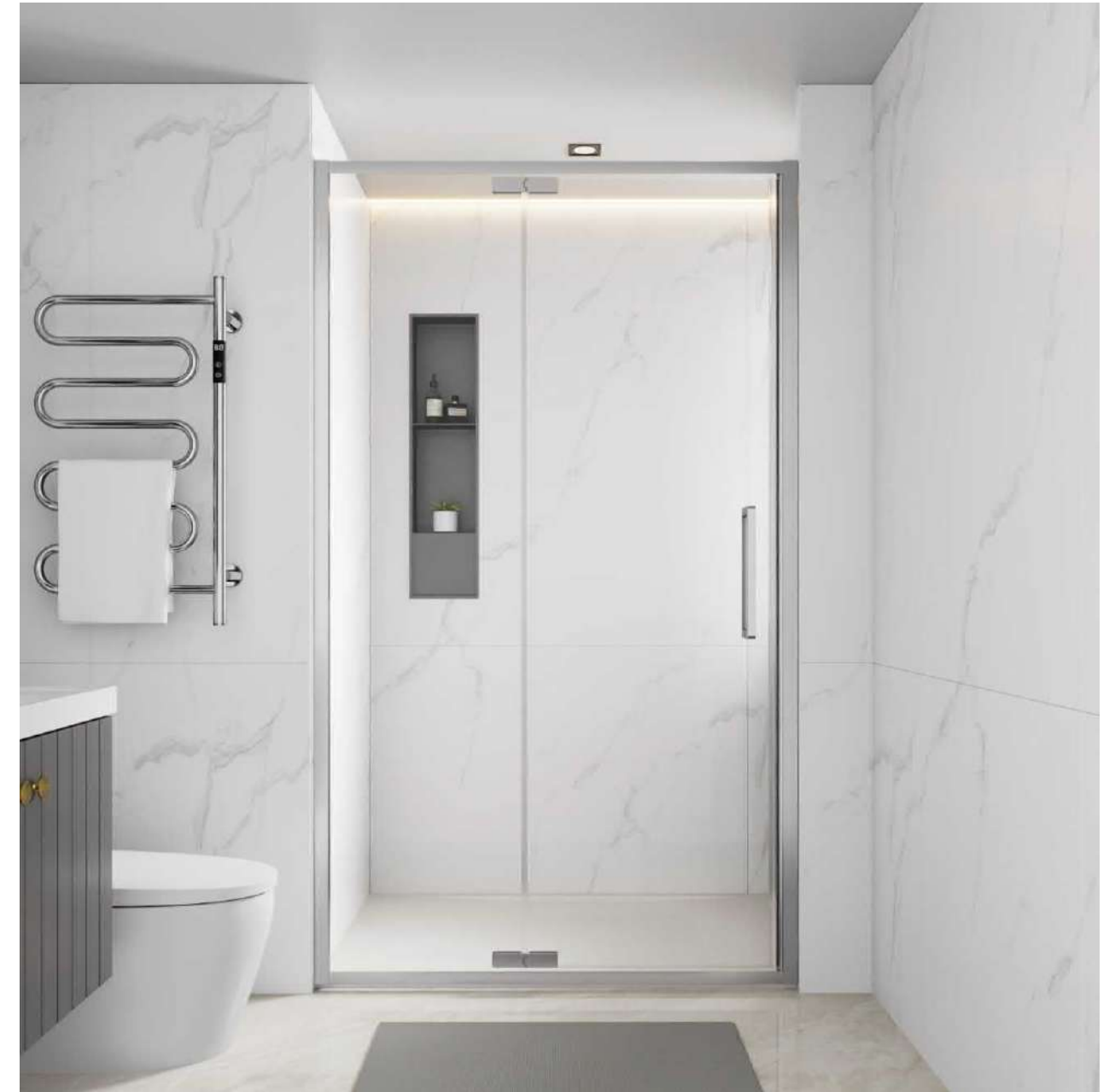

Width B	Adjustment min-max B	Door opening C
700	680-700	552
760	740-760	612
800	780-800	652
900	880-900	752

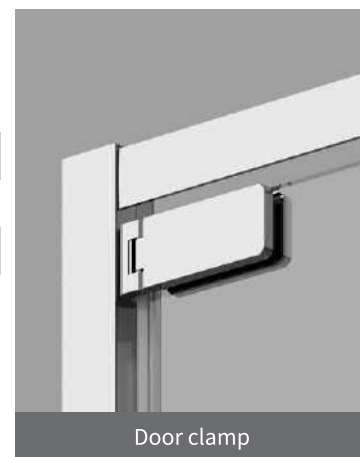
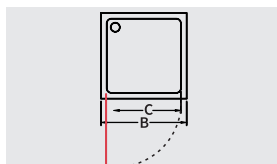

EI-P721

Width B	Adjustment min-max B	Door opening C
900	880-900	539
1000	980-1000	589
1100	1080-1100	589
1200	1180-1200	589
1400	1380-1400	589
1500	1480-1500	589
1600	1580-1600	589
1700	1680-1700	589

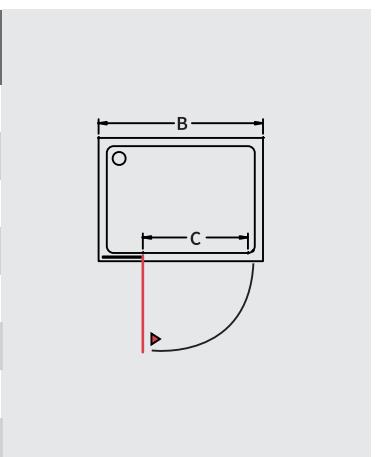

Shower door / **FJ SERIES**



FRAME MATERIAL: Stainless steel frame

FRAME COLORS

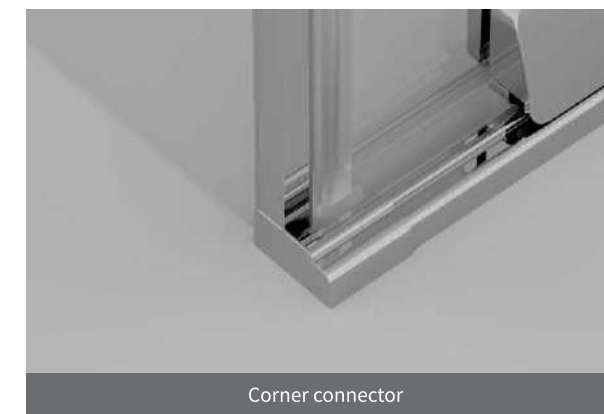
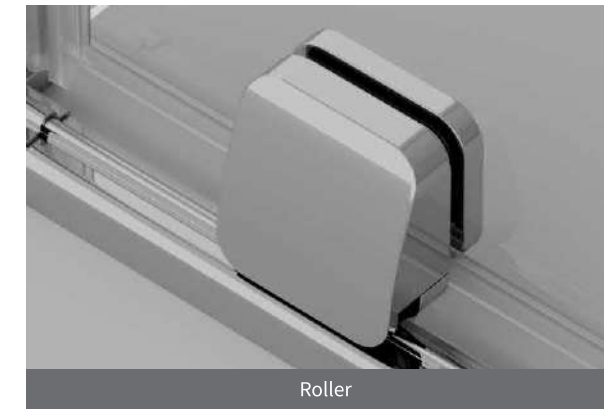
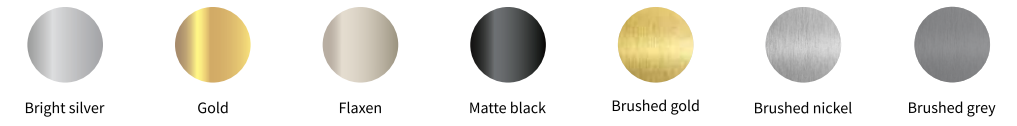

*Other handles are available. For more information, please see page 13.



Width B	Adjustment min-max B	Door opening C
1000	980-1000	406
1100	1080-1100	456
1200	1180-1200	506
1400	1380-1400	606
1500	1480-1500	656
1600	1580-1600	706
1700	1680-1700	756

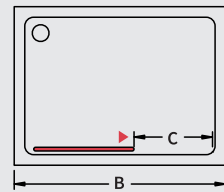

Width B	Adjustment min-max B	Door opening C
700	680-700	
800	780-800	
900	880-900	
1000	980-1000	

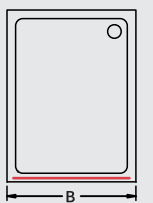



Width B	Adjustment min-max B	Door opening C
1200	1180-1200	570
1400	1380-1400	670
1500	1480-1500	720
1600	1580-1600	720
1700	1680-1700	720

Width B1/B2	Adjustment min-max B	Door opening C
800	780-800	394
900	880-900	465
1000	980-1000	465

Shower door / **FN SERIES**



FRAME MATERIAL: Stainless steel frame

FRAME COLORS

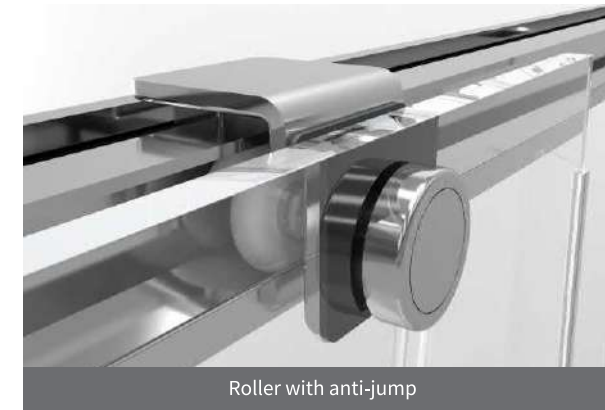

*Other handles are available. For more information, please see page 13.



Width B	Adjustment min-max B	Door opening C
1100	1070-1100	410
1200	1170-1200	460
1400	1370-1400	610
1500	1470-1500	610
1600	1570-1600	610
1700	1670-1700	610

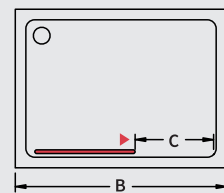

Width B	Adjustment min-max B	Door opening C
700	675-690	
760	735-750	
800	775-790	
900	885-890	

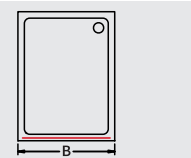



Width B	Adjustment min-max B	Door opening C
700	680-695	555
760	740-755	615
800	780-795	655
900	880-895	755

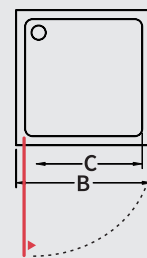

Width B	Adjustment min-max B	Door opening C
800	780-795	520
900	880-895	620
1000	980-995	620
1200	1180-1195	620
1400	1380-1395	620

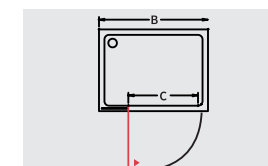

Buffer door clamp



Width B	Adjustment min-max B	Door opening C
700	675-690	
760	735-750	
800	775-790	
900	885-890	

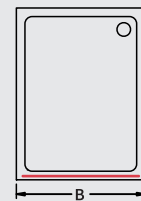

Width B1/B2	Adjustment min-max B	Door opening C
800/800	770-785/770-785	410
900/900	870-885/870-885	440
1000/1000	970-985/970-985	440
800/1000	770-785/970-985	440
800/1200	770-785/1170-1185	440
900/1200	870-885/1170-1185	440



Wall-to-rail connector



Width B	Adjustment min-max B	Door opening C
700	670-700	450
760	730-760	510
800	770-800	550
900	870-900	650

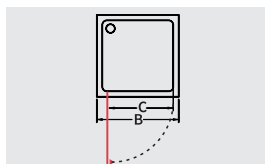

Width B	Adjustment min-max B	Door opening C
700	675-690	
760	735-750	
800	775-790	
900	885-890	

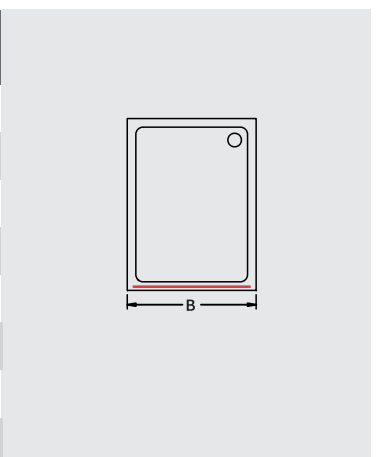



FRAME MATERIAL: Stainless steel frame



8
mm
GLASS
THICKNESS

↑
↓
HEIGHT
2000MM

15
mm
PRODUCT
ADJUSTMENT

↔
REVERSIBLE FOR
LEFT OR RIGHT

⬆
ALL SCREWS
ARE HIDDEN

*Other handles are available. For more information, please see page 13.



Width B	Adjustment min-max B	Door opening C
700	670-700	605
760	730-760	625
800	770-800	645
900	870-900	665

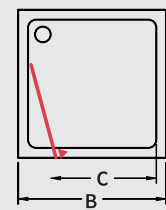

Width B	Adjustment min-max B	Door opening C
700	675-690	
760	735-750	
800	775-790	
900	885-890	

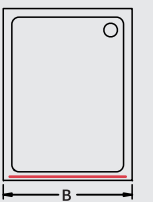



FRAME MATERIAL: Aluminum

FRAME COLORS

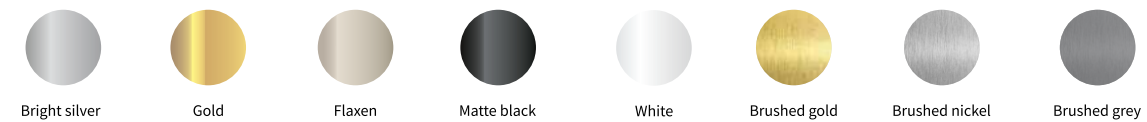

*Other handles are available. For more information, please see page 13.



Width B	Adjustment min-max B	Door opening C
700	680-700	610
760	740-760	650
800	780-800	710
900	880-900	810

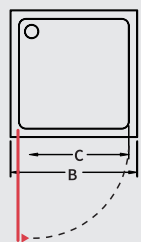

Width B	Adjustment min-max B	Door opening C
900	880-900	650
1000	980-1000	650
1200	1180-1200	650
1400	1390-1400	650

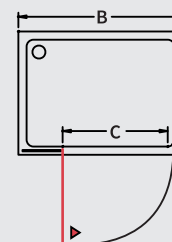

Shower door / **AEN SERIES**

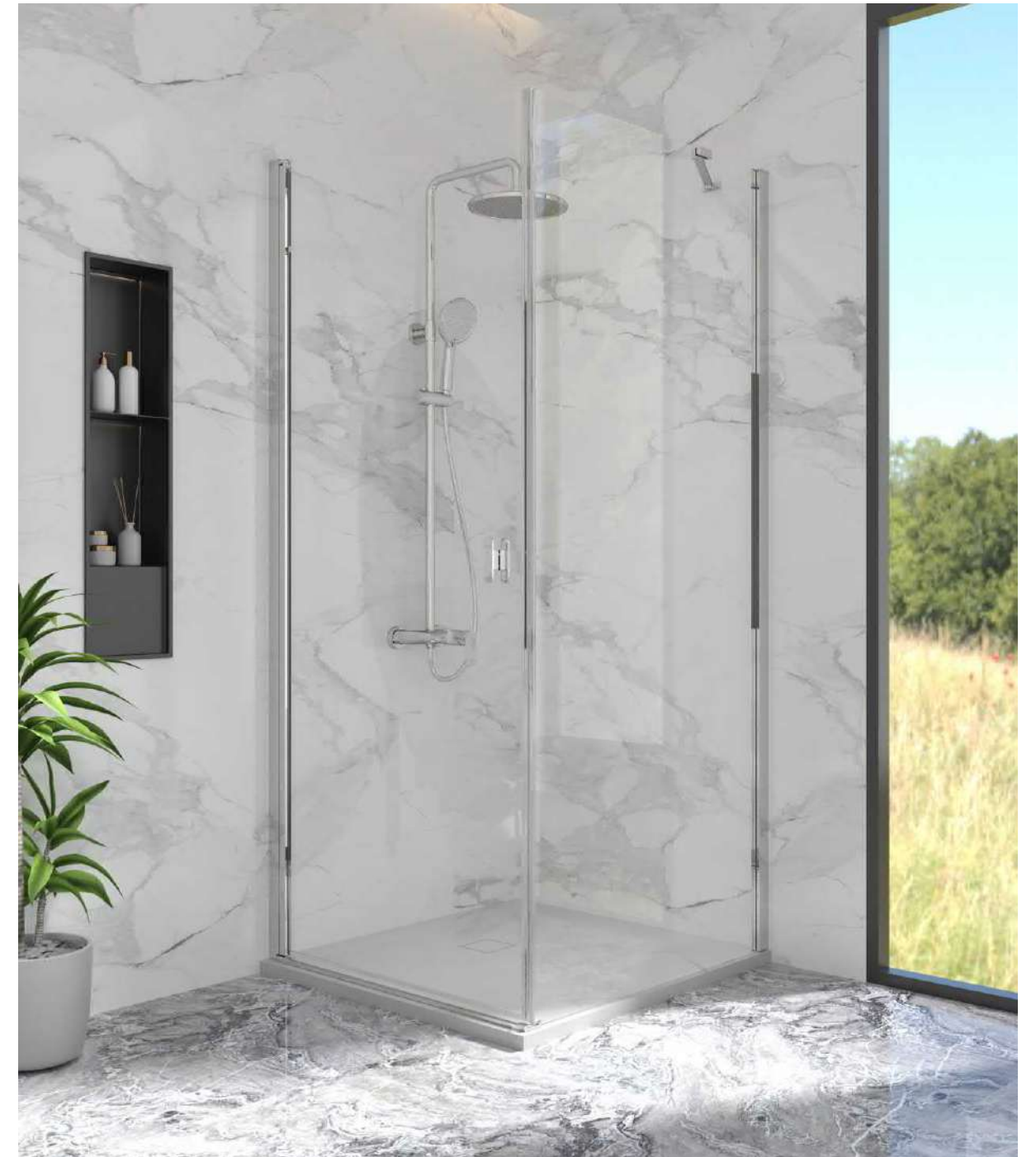

Width B	Adjustment min-max B
700	670-690
760	730-750
800	770-790
900	870-890
1000	970-990



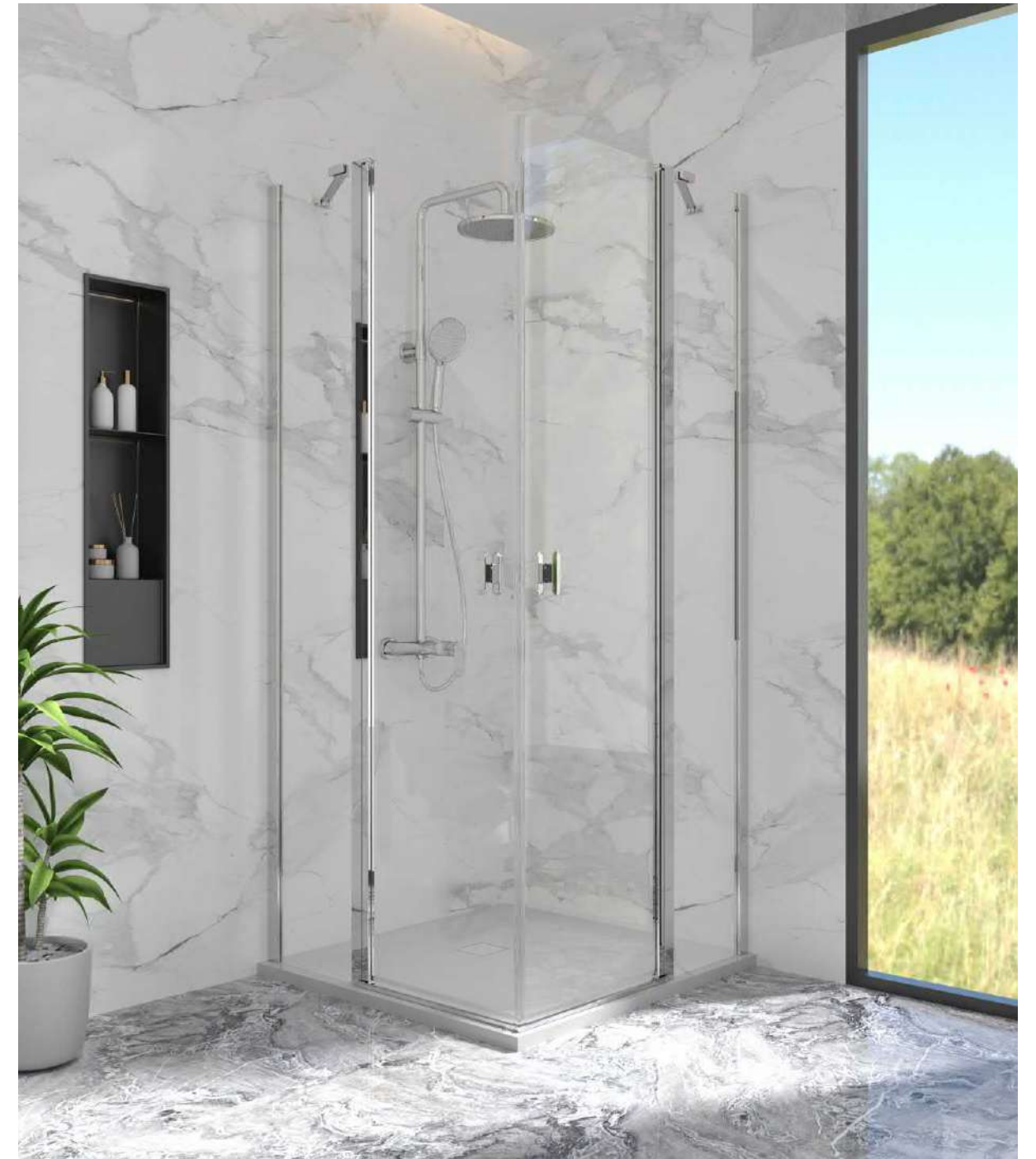

Width B1/B2	Adjustment min-max B1/B2	Door opening C
800 / 800	780-790 / 780-790	680
900 / 900	870-890 / 870-890	680
1000 / 1000	970-990 / 970-990	680

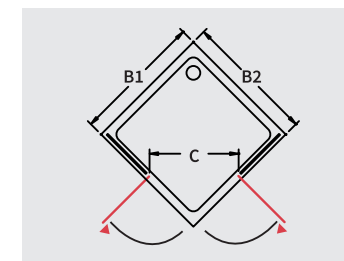
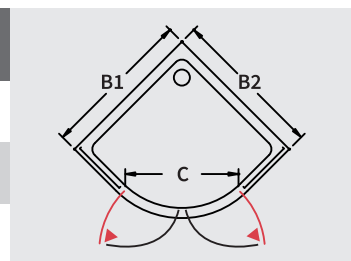

Width B1/B2	Adjustment min-max B1/B2	Door opening C
800 / 800	770-790 / 770-790	760
900 / 900	870-890 / 870-890	760
1000 / 1000	970-990 / 970-990	760



FRAME COLORS



Width B	Adjustment min-max B	Door opening C
700	680-690	600
760	740-750	660
800	780-790	700
900	980-990	800

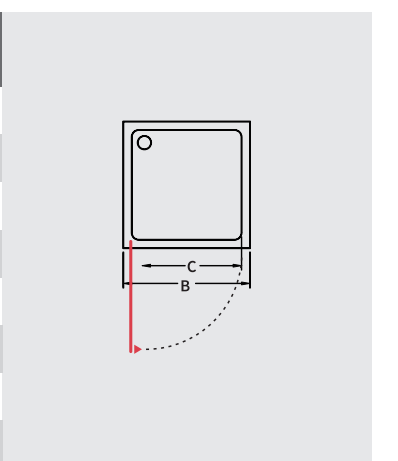

*Other handles are available. For more information, please see page 13.

**FAST
INSTALLATION**



FRAME MATERIAL: Aluminum

FRAME COLORS

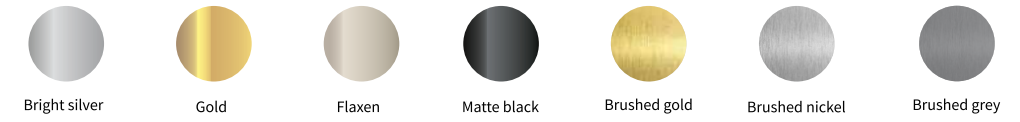

Hanging clamp detail image



S722 door bottom guide detail image



*Other handles are available. For more information, please see page 13.



90° positioning pivot design.

Width B	Adjustment min-max B	Door opening C
900	880-900	450
1000	980-1000	450
1100	1080-1100	450
1200	1180-1200	500
1400	1380-1400	600
1500	1480-1500	650
1600	1580-1600	700
1700	1680-1700	750

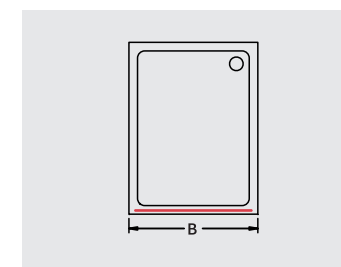
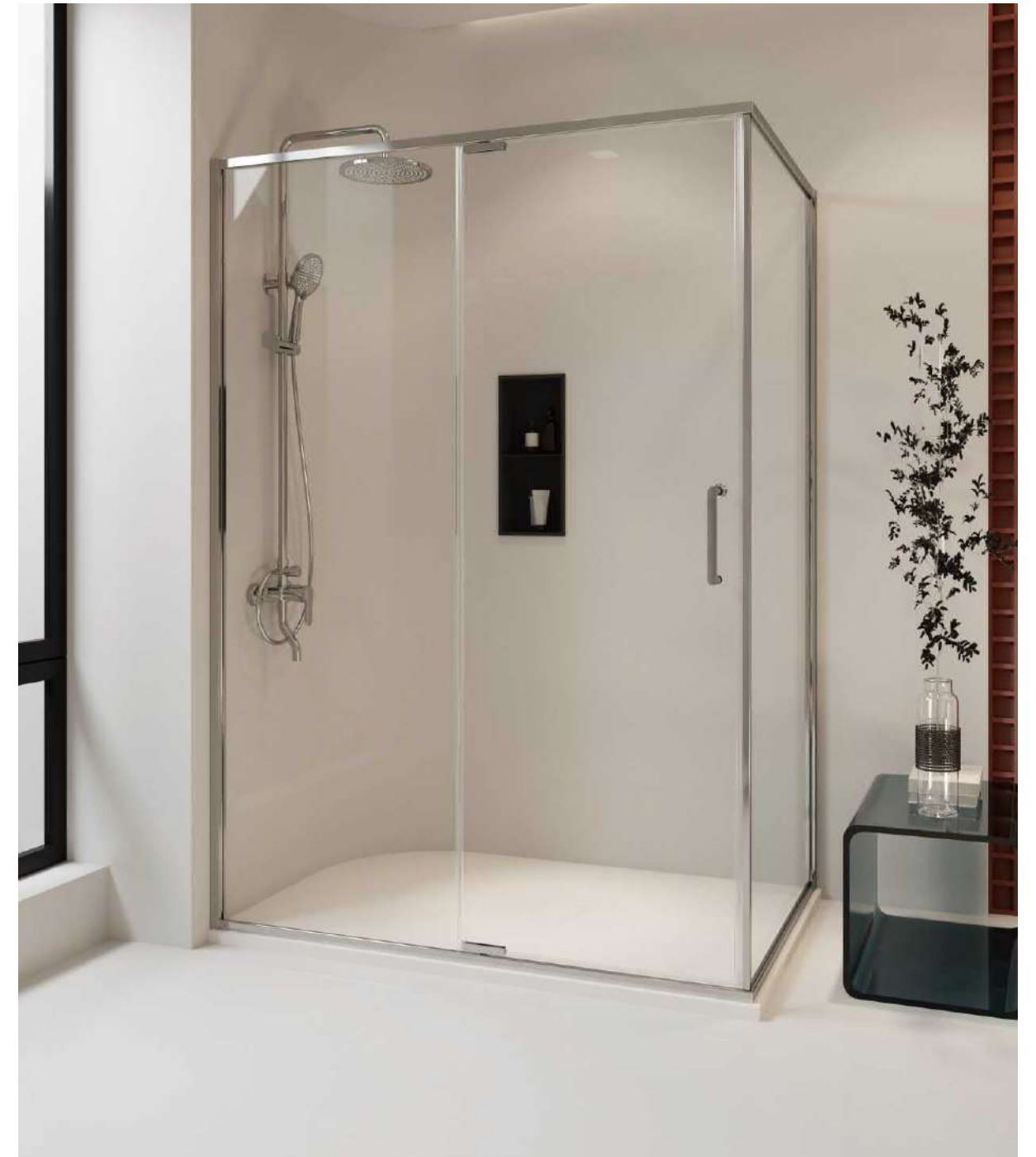
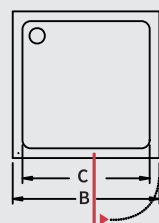

Width B	Adjustment min-max B
700	680-700
760	740-760
800	780-800
900	880-900
1000	980-1000

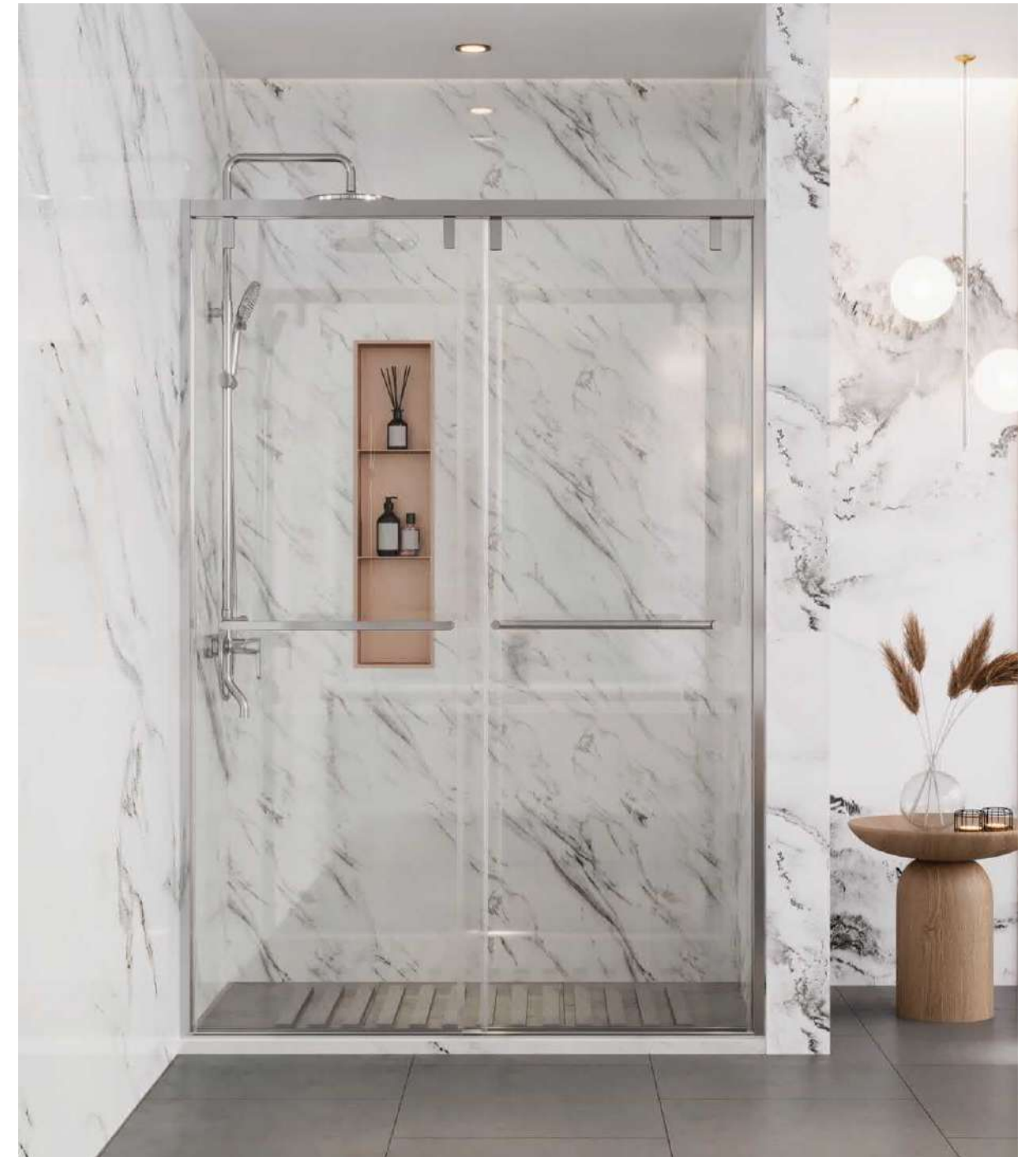

Width B	Adjustment min-max B	Door opening C
900	880-900	450
1000	980-1000	450
1100	1080-1100	450
1200	1180-1200	500
1400	1380-1400	600
1500	1480-1500	650
1600	1580-1600	700
1700	1680-1700	750

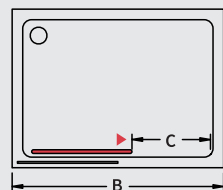

*AY2-S722 magnetic door closure for better waterproof performance.

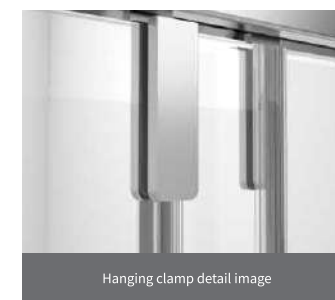

Hanging clamp detail image

Width B	Adjustment min-max B	Door opening C
48"(1219mm)	1143-1219	489-565
60"(1524mm)	1448-1524	639-715

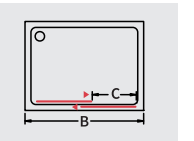

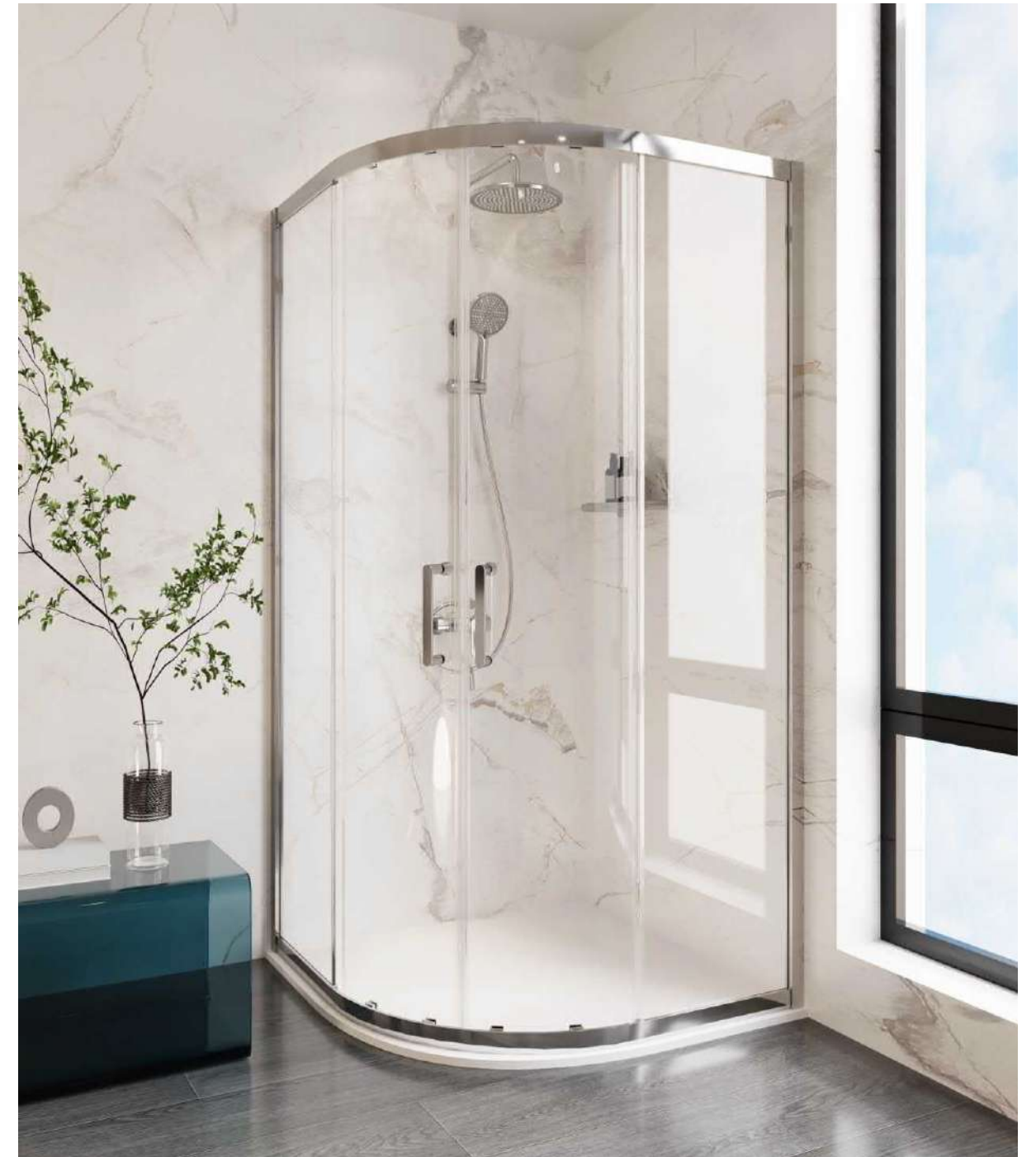

Width B	Adjustment min-max B
700	680-700
760	740-760
800	780-800
900	880-900
1000	980-1000

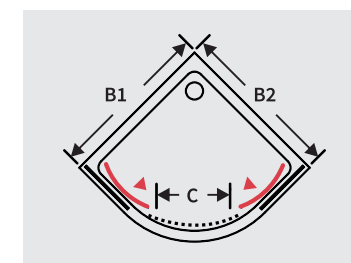
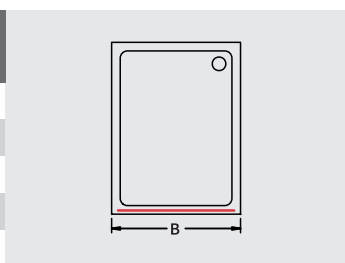

Width B1/B2	Adjustment min-max B1/B2	Door opening C
760 / 900	745-760/885-900	550
800 / 800	785-800/785-800	550
900 / 900	885-900/885-900	550
1000 / 1000	985-1000/985-1000	550
800 / 1000	785-1000/785-1000	550
800 / 1200	785-1200/785-1200	550
900 / 1200	885-1200/885-1200	550



Width B	Adjustment min-max B	Door opening C
900	880-900	450
1000	980-1000	450
1100	1080-1100	450
1200	1180-1200	500
1400	1380-1400	600
1500	1480-1500	650
1600	1580-1600	700
1700	1680-1700	750

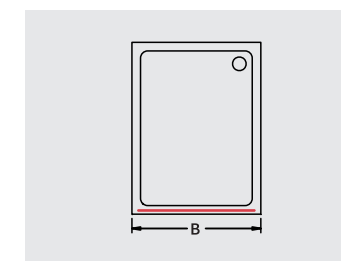
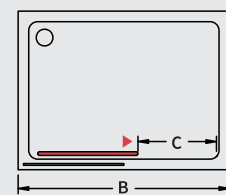

Width B	Adjustment min-max B
700	680-700
760	740-760
800	780-800
900	880-900
1000	980-1000

Shower door / **EH SERIES**



FRAME MATERIAL: Aluminum

FRAME COLORS



EH-YP-S722	Width B	Adjustment min-max B	Door opening C
	900	885-900	835
	1000	985-1000	935

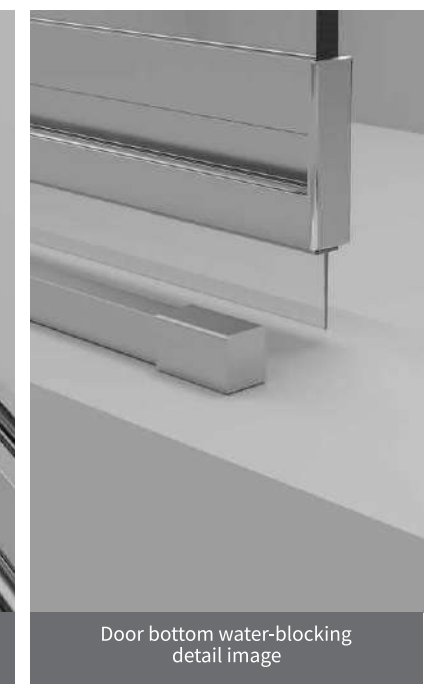
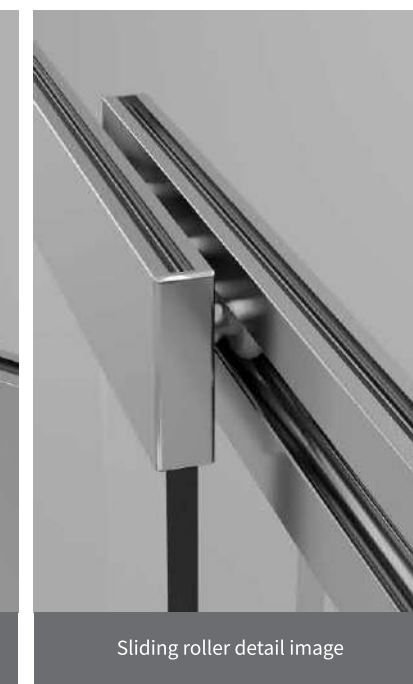

- 6**
mm
GLASS THICKNESS
- 1500**
mm
HEIGHT
- 15**
mm
PRODUCT ADJUSTMENT
- REVERSIBLE FOR LEFT OR RIGHT
- CONCEALED SLIDING ROLLER DESIGN

*Other handles are available. For more information, please see page 13.



FRAME MATERIAL: Aluminium frame

FRAME COLORS

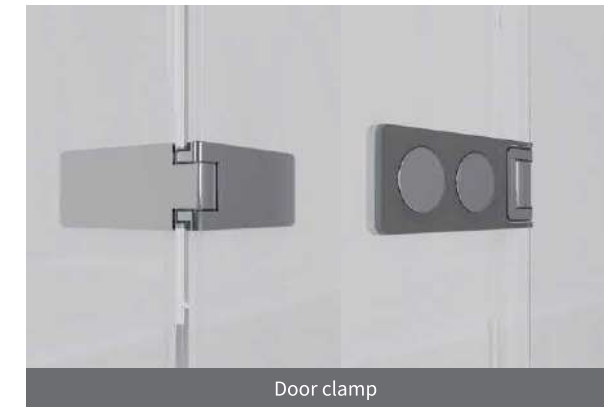
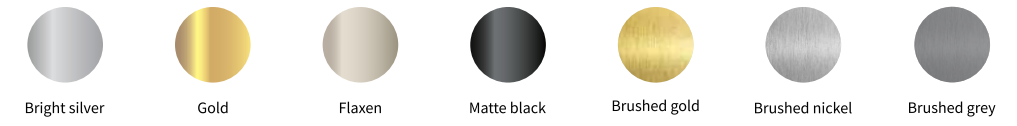

Door clamp



Support bar & glass clamp



Bottom water-retaining system



Handle



GLASS THICKNESS

HEIGHT

PRODUCT ADJUSTMENT

REVERSIBLE FOR LEFT OR RIGHT

ALL SCREWS ARE HIDDEN

*Other handles are available. For more information, please see page 13.



Width B	Adjustment min-max B	Door opening C
1200	1185-1200	595
1400	1385-1400	595
1500	1485-1500	595
1600	1585-1600	595
1700	1685-1700	595

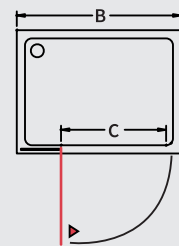

Width B	Adjustment min-max B	Door opening C
1000	985-1000	595
1100	1085-1100	595
1200	1185-1200	595
1400	1385-1400	595
1500	1485-1500	595
1600	1585-1600	595
1700	1685-1700	595

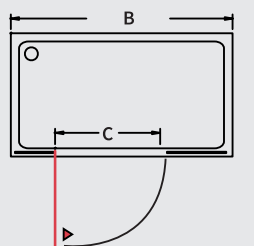



Width B1/B2	Adjustment min-max B	Door opening C
800	785-800	709
900	885-900	850
1000	985-1000	850

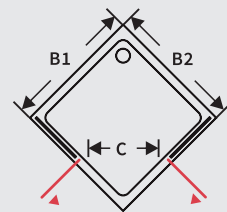

Width B	Adjustment min-max B	Door opening C
900	885-900	607
1000	985-1000	607

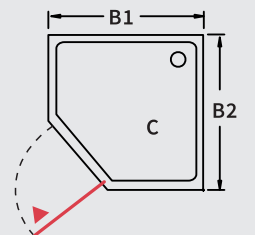



Width B	Adjustment min-max B	Door opening C
700	685-700	
760	745-760	
800	785-800	
900	885-900	
1000	985-1000	

Width B	Adjustment min-max B	Door opening C
700	685-700	
760	745-760	
800	785-800	
900	885-900	
1000	985-1000	



FRAME MATERIAL: Stainless steel frame

FRAME COLORS

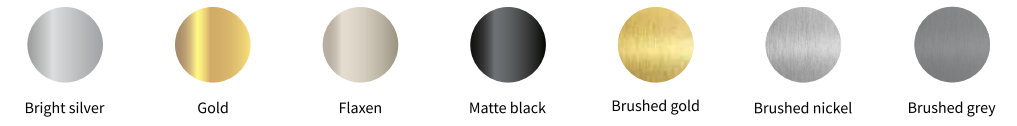

Width B	Adjustment min-max B	Door opening C
700	690-700	679
760	750-760	739
800	790-800	779
900	890-900	879

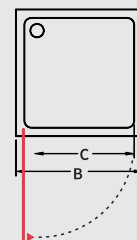

- 

10
mm
GLASS
THICKNESS
- 

HEIGHT
2000MM
- 

10
mm
PRODUCT
ADJUSTMENT
- 

REVERSIBLE FOR
LEFT OR RIGHT
- 

ALL SCREWS
ARE HIDDEN

*Other handles are available. For more information, please see page 13.



Width B	Adjustment min-max B	Door opening C
1000	990-1000	649
1100	1090-1100	714
1200	1190-1200	714
1400	1390-1400	714
1500	1490-1500	714
1600	1590-1600	714
1700	1690-1700	714

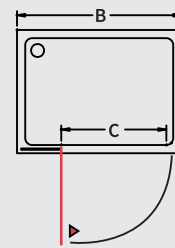

Width B	Adjustment min-max B	Door opening C
700	690-700	
760	750-760	
800	790-800	
900	890-900	
1000	990-1000	

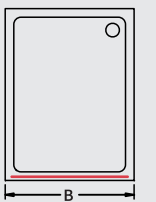



FRAME MATERIAL: Aluminum

FRAME COLORS



	Width B	Adjustment min-max B	Door opening C
	1000 * 1000	975-990	520



Closing mechanism detail image

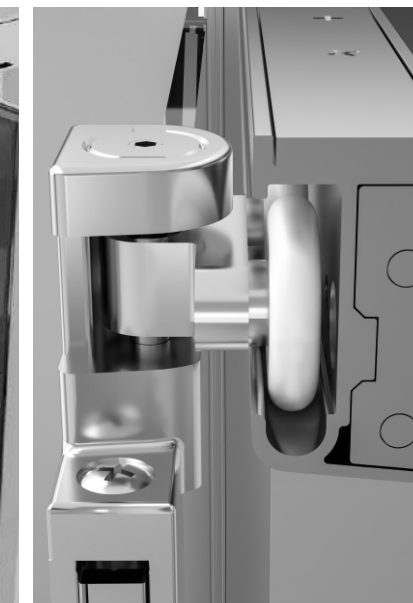

Roller detail image



Adjustment detail image

- 8
mm
GLASS
THICKNESS
- HEIGHT
2000MM
- 15
mm
PRODUCT
ADJUSTMENT
- REVERSIBLE FOR
LEFT OR RIGHT
- MAGNETIC
CLOSURE

*Other handles are available. For more information, please see page 13.



Width B1 / B2	Adjustment min-max B	Door opening C
760 / 760	725-740	520
800 / 800	775-790	585
900 / 900	875-890	650

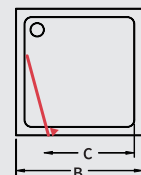

Width B	Adjustment min-max B	Door opening C
800 / 800	775-790	575
900 / 900	875-890	575
1000 / 1000	975-990	575

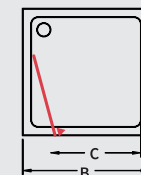



FRAME MATERIAL: Aluminium frame

FRAME COLORS

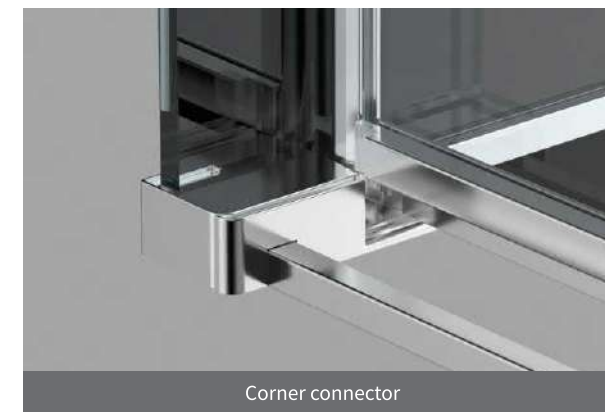
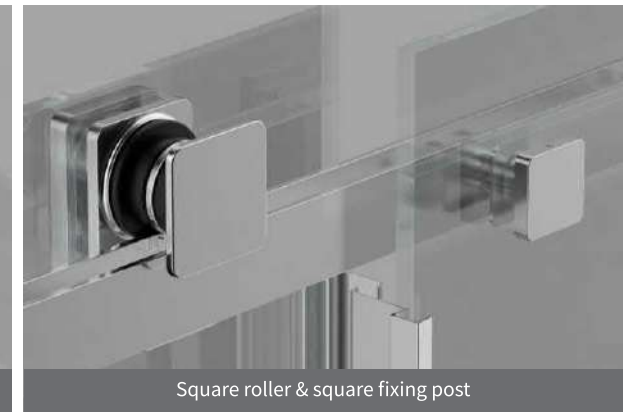
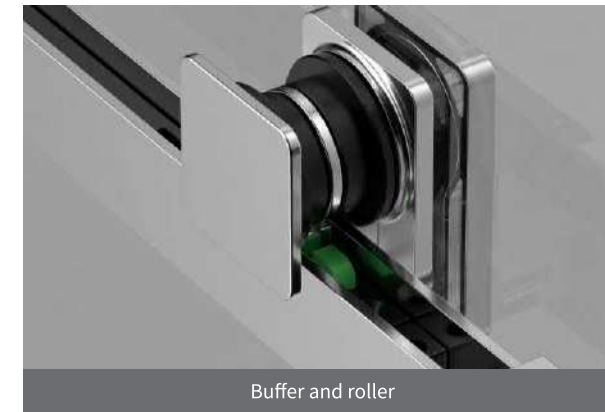

*Other handles are available. For more information, please see page 13.



Width B	Adjustment min-max B	Door opening C
1000	980-990	409
1100	1080-1090	459
1200	1180-1190	509
1400	1380-1390	609
1500	1480-1490	709
1600	1580-1590	709
1700	1680-1690	709

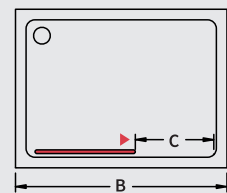

Width B	Adjustment min-max B	Door opening C
700	690-800	
760	750-760	
800	790-800	
900	890-900	
1000	990-1000	

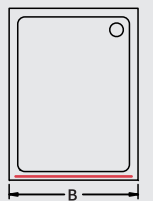



FRAME MATERIAL: Aluminium frame or Stainless steel frame

FRAME COLORS

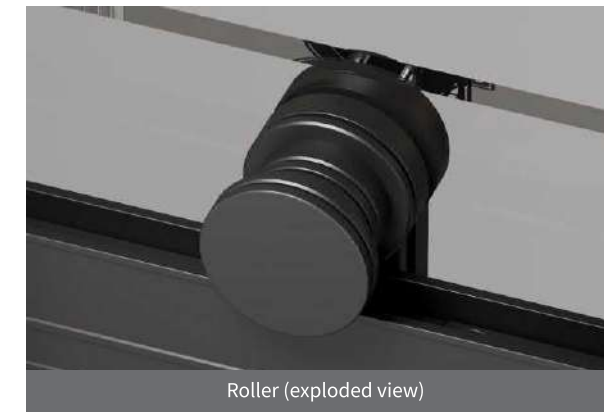
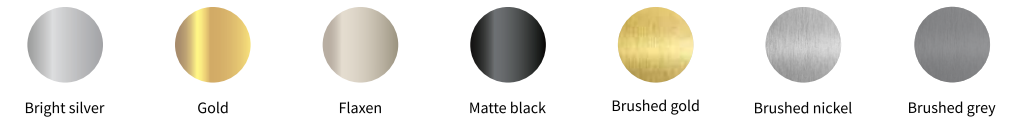

Roller (exploded view)

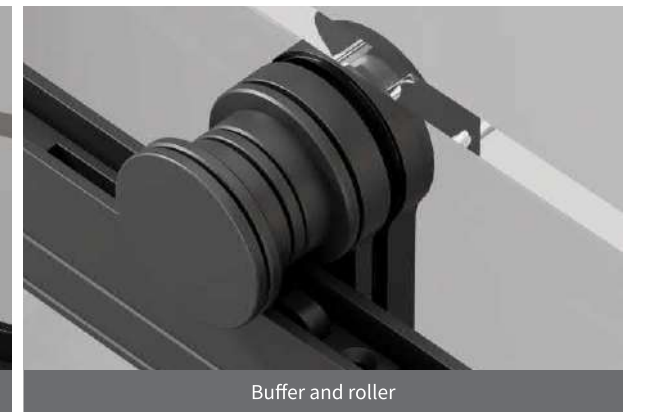

Buffer and roller



Corner connector



Track



8
mm
GLASS
THICKNESS

2000
mm
HEIGHT

15
mm
PRODUCT
ADJUSTMENT

REVERSIBLE FOR
LEFT OR RIGHT

ALL SCREWS
ARE HIDDEN

*Other handles are available. For more information, please see page 13.



Width B	Adjustment min-max B	Door opening C
1000	980-990	409
1100	1080-1090	459
1200	1180-1190	509
1400	1380-1390	609
1500	1480-1490	709
1600	1580-1590	709
1700	1680-1690	709

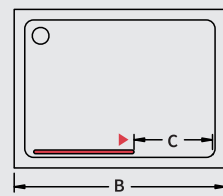

Width B	Adjustment min-max B	Door opening C
700	690-800	
760	750-760	
800	790-800	
900	890-900	
1000	990-1000	

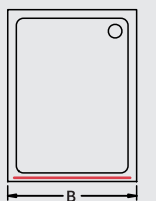

**FAST
INSTALLATION**



FRAME MATERIAL: Aluminum

FRAME COLORS

-  Bright silver
-  Gold
-  Flaxen
-  Matte black
-  Brushed gold
-  Brushed nickel
-  Brushed grey

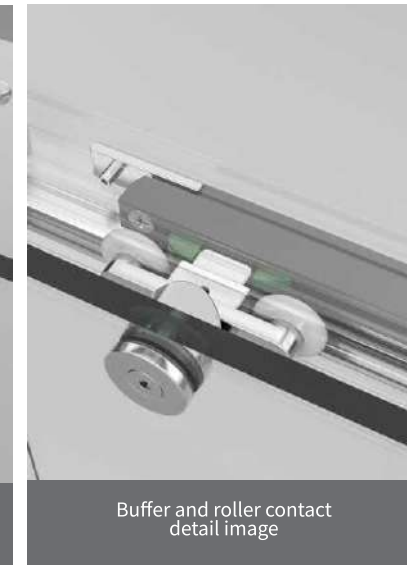

-  **8**
mm
GLASS THICKNESS
-  **2000**
mm
HEIGHT
-  **15**
mm
PRODUCT ADJUSTMENT
-  **REVERSIBLE FOR LEFT OR RIGHT**
-  **ALL SCREWS ARE HIDDEN**
-  **SOFT CLOSE**
-  **FAST INSTALLATION**

*Other handles are available. For more information, please see page 13.



Width B	Adjustment min-max B	Door opening C
1000	975-990	389
1100	1075-1190	439
1200	1175-1190	489
1400	1375-1390	589
1500	1475-1490	639
1600	1575-1590	639
1700	1675-1690	639

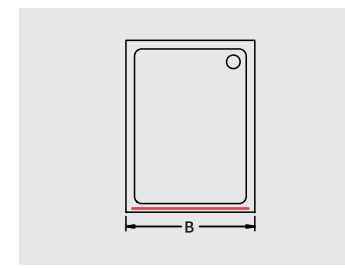
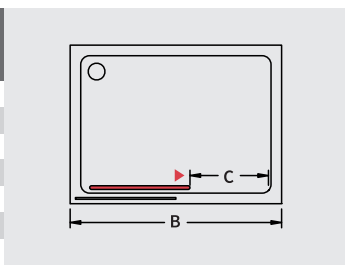

Width B	Adjustment min-max B
700	675-690
760	735-750
800	775-790
900	875-890
1000	975-990

Shower door / **DU SERIES**



FRAME MATERIAL: Aluminium frame

FRAME COLORS

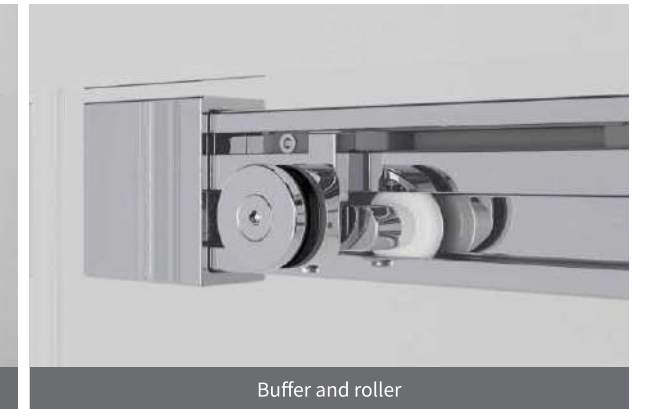

*Other handles are available. For more information, please see page 13.

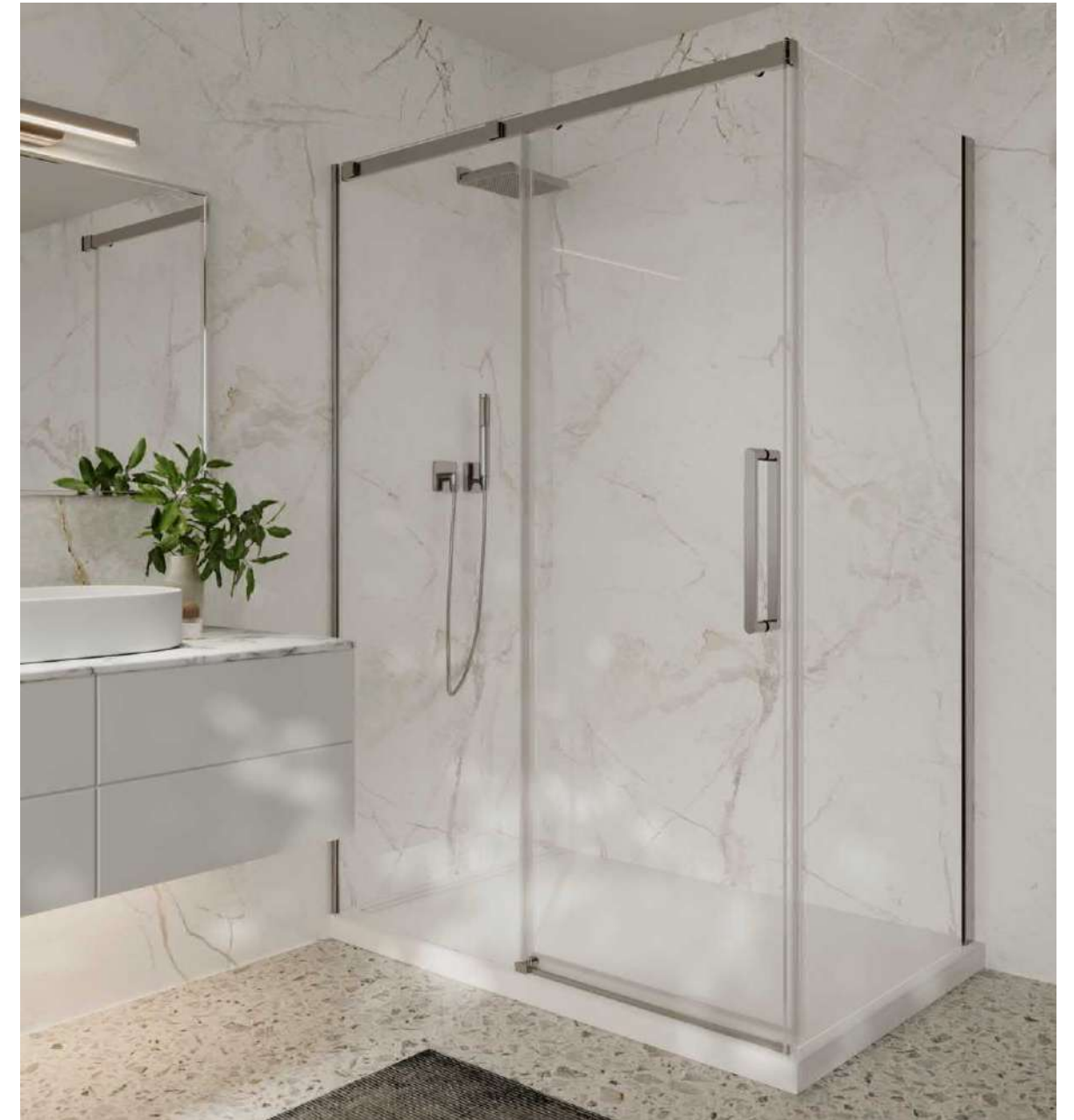

Width B	Adjustment min-max B	Door opening C
1000	985-1000	389
1100	1085-1100	439
1200	1185-1200	489
1400	1385-1400	589
1500	1485-1500	589
1600	1585-1600	589
1700	1685-1700	589

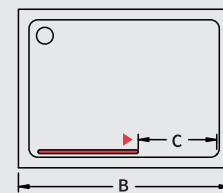

Width B	Adjustment min-max B	Door opening C
700	685-700	
760	745-760	
800	785-800	
900	885-900	
1000	985-1000	

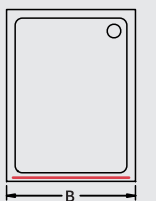



FRAME MATERIAL: Aluminium frame

FRAME COLORS

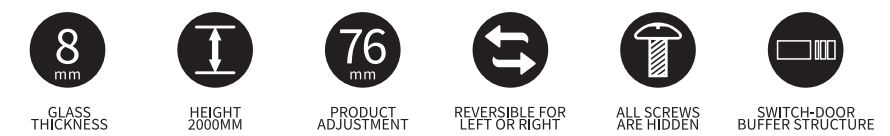
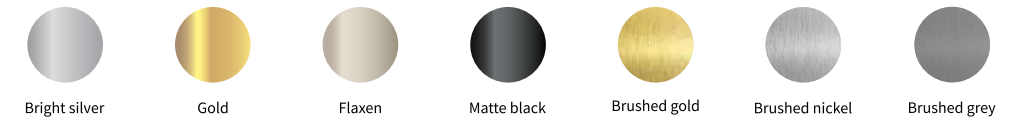

*Other handles are available. For more information, please see page 13.



Width B	Adjustment min-max B	Door opening C
1000	985-1000	410
1100	1085-1100	460
1200	1185-1200	610
1400	1385-1400	610
1500	1485-1500	610
1600	1585-1600	610
1700	1685-1700	610

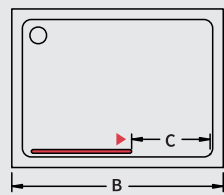

Width B	Adjustment min-max B	Door opening C
700	675-690	
760	735-750	
800	775-790	
900	875-890	

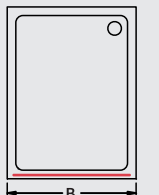



FRAME MATERIAL: Aluminum

FRAME COLORS



	Width B	Adjustment min-max B	Door opening C
	1000	970-990	390
	1100	1070-1090	440
	1200	1170-1190	490
	1400	1370-1390	590
	1500	1470-1490	590
	1600	1570-1590	590
	1700	1670-1690	590

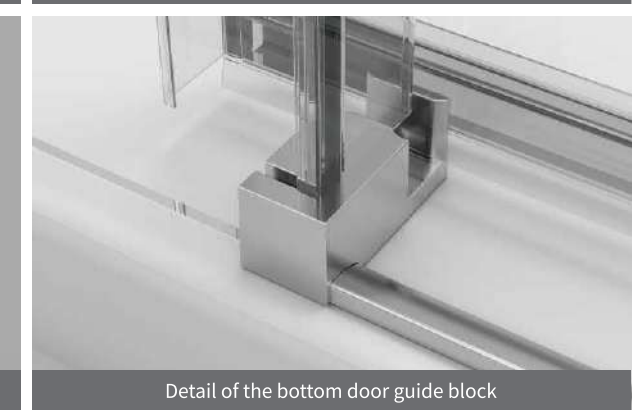
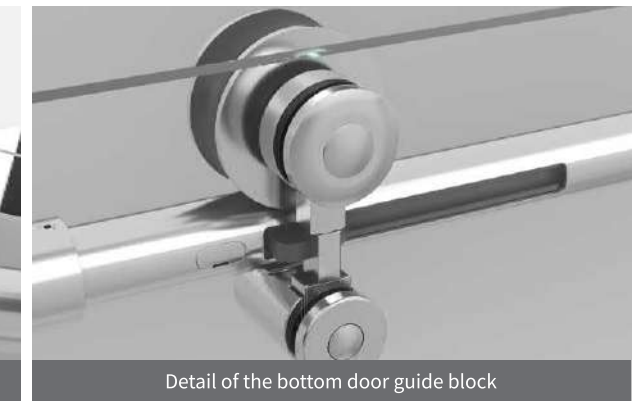

y



FRAME MATERIAL: Stainless steel frame

FRAME COLORS

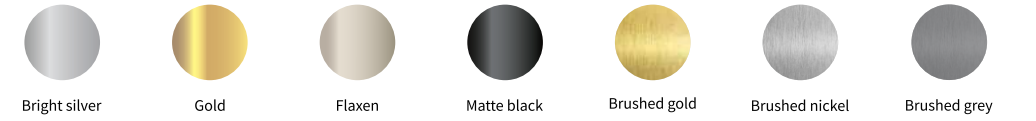



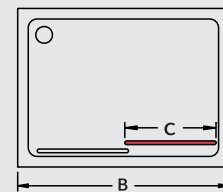

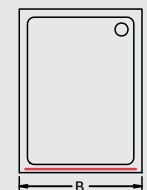

Width B	Adjustment min-max B	Door opening C
1000	985-1000	428
1100	1085-1100	478
1200	1185-1200	528
1400	1385-1400	578
1500	1485-1500	578
1600	1585-1600	578
1700	1685-1700	578



Width B	Adjustment min-max B	Door opening C
700	675-690	
760	735-750	
800	775-790	
900	875-890	



- 
8
mm
GLASS THICKNESS
- 
2000
HEIGHT
- 
76
mm
PRODUCT ADJUSTMENT
- 
 REVERSIBLE FOR LEFT OR RIGHT
- 
 ALL SCREWS ARE HIDDEN
- 
 SWITCH-DOOR BUFFER STRUCTURE

*Other handles are available. For more information, please see page 13.



FRAME MATERIAL: Aluminum

FRAME COLORS



	Width B	Adjustment min-max B	Door opening C
	1000	940-1000	350-410
	1100	1040-1100	400-460
	1200	1140-1200	450-510
	1400	1340-1400	500-560
	1500	1440-1500	550-610
	1600	1540-1600	600-660
	1700	1640-1700	650-710

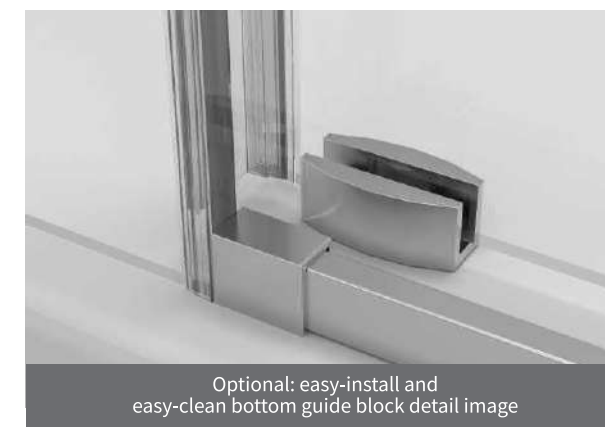
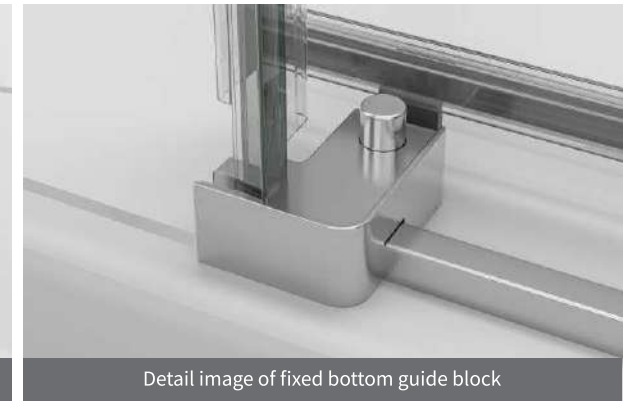

- 10
mm
GLASS
THICKNESS
- HEIGHT
2000MM
- 76
mm
PRODUCT
ADJUSTMENT
- REVERSIBLE FOR
LEFT OR RIGHT
- ALL SCREWS
ARE HIDDEN
- φ70 SUSPENSION
ROLLER



FRAME MATERIAL: Aluminium frame

FRAME COLORS

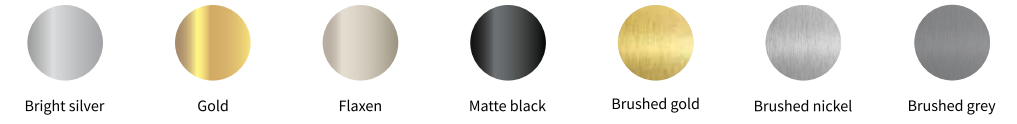

Width B	Adjustment min-max B	Door opening C
1000	995-1000	427
1100	1095-1100	477
1200	1195-1200	527
1300	1295-1300	577
1400	1395-1400	627
1500	1495-1500	677

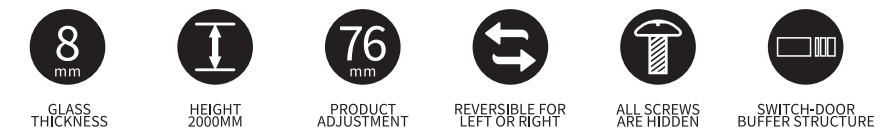
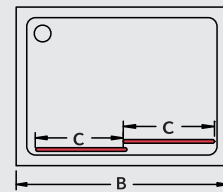

*Other handles are available. For more information, please see page 13.

Shower door / **DE SERIES**



FRAME MATERIAL: Aluminum

FRAME COLORS

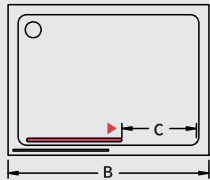

DE-S722	Width B	Product code	Adjustment min-max B	Door opening C
	48"(1219mm)	DE-S722-A	1143-1219	489-565
	60"(1524mm)	DE-S722-B	1448-1524	639-715



Close-door clamp detail image

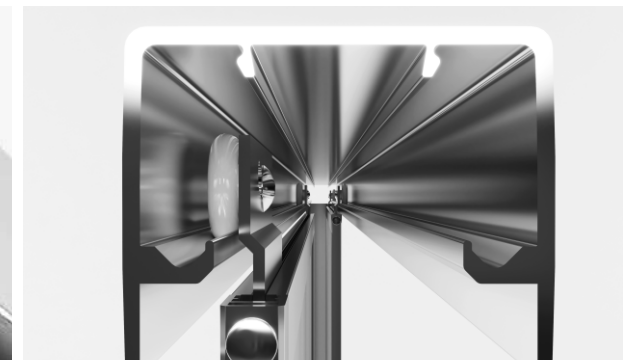

Upper rail cross-section detail image



Bottom guide block detail image

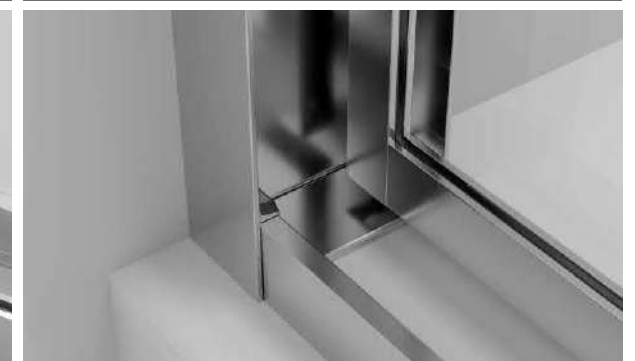

Plastic cover design detail at the bottom rail and vertical material connection

- 
6
mm
GLASS THICKNESS
- 
HEIGHT
2000MM
- 
76
mm
PRODUCT ADJUSTMENT
- 
REVERSIBLE FOR
LEFT OR RIGHT
- 
ALL SCREWS
ARE HIDDEN
- 
GLASS FRAME
DESIGN

*Other handles are available. For more information, please see page 13.



FRAME MATERIAL: Aluminum or Stainless steel frame

FRAME COLORS



	Width B	Adjustment min-max B	Door opening C
	48"(1219mm)	1143-1219	489-565
	60"(1524mm)	1448-1524	639-715



Suspension clamp detail image

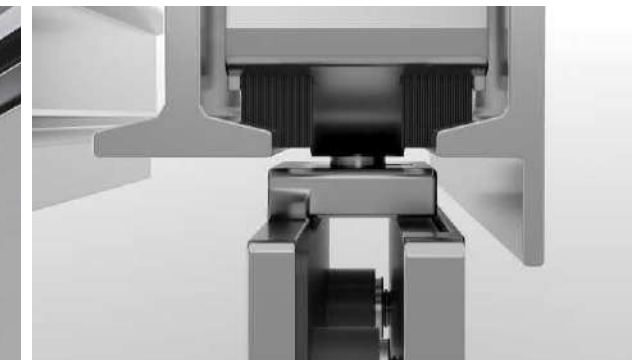

Rail groove with self-cleaning function detail image

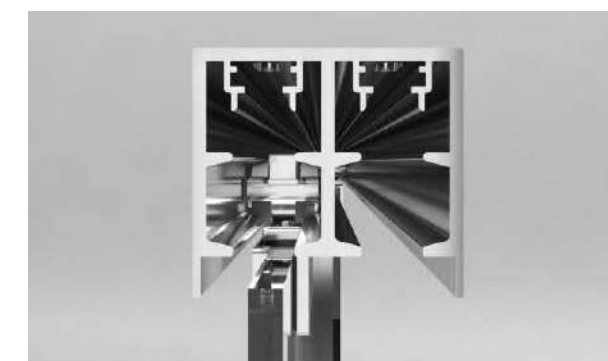

Rail cross-section detail image



Waterproof detail image of the door glass and seal strip

- 8
mm
GLASS
THICKNESS
- HEIGHT
2000MM
- 76
mm
PRODUCT
ADJUSTMENT
- REVERSIBLE FOR
LEFT OR RIGHT
- ALL SCREWS
ARE HIDDEN
- SOFT CLOSE

*Other handles are available. For more information, please see page 13.

Shower door / **PB SERIES**



FRAME MATERIAL: Aluminum

FRAME COLORS

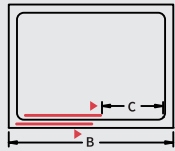

	Width B	Adjustment min-max B	Door opening C
	48" (1219mm)	1143-1219	489-565
	60" (1524mm)	1448-1524	639-715

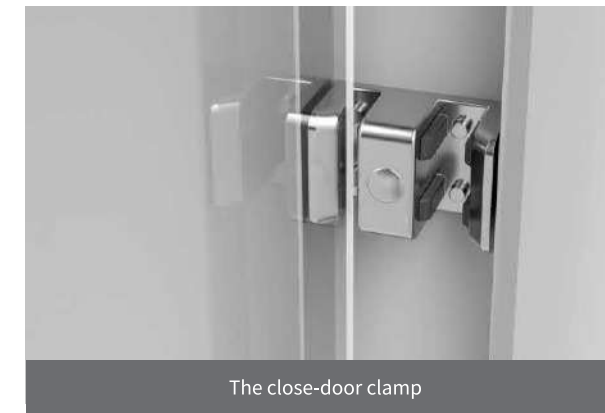

The close-door clamp

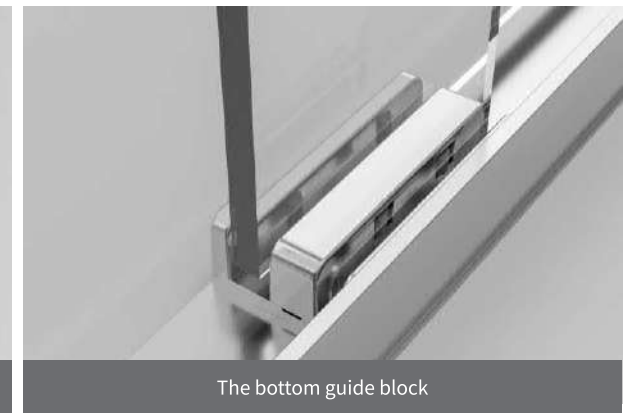

The bottom guide block



The upper rail cross-section



The plastic cover design at the connection between the bottom rail and vertical profile.

- 
GLASS THICKNESS
- 
HEIGHT 2000MM
- 
PRODUCT ADJUSTMENT
- 
REVERSIBLE FOR LEFT OR RIGHT
- 
ALL SCREWS ARE HIDDEN

*Other handles are available. For more information, please see page 13.

Shower door / **CV SERIES**



FRAME MATERIAL: Aluminum

FRAME COLORS

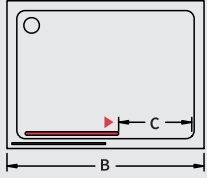

CV-S722	Width B	Product code	Adjustment min-max B	Door opening C
	48"(1219mm)	CV-S722-A	1143-1219	489-565
	60"(1524mm)	CV-S722-B	1448-1524	639-715

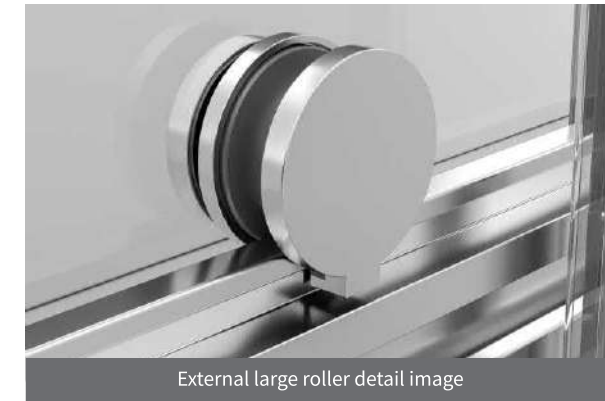

- 
GLASS THICKNESS
- 
HEIGHT 2000MM
- 
PRODUCT ADJUSTMENT
- 
REVERSIBLE FOR LEFT OR RIGHT
- 
ALL SCREWS ARE HIDDEN

*Other handles are available. For more information, please see page 13.

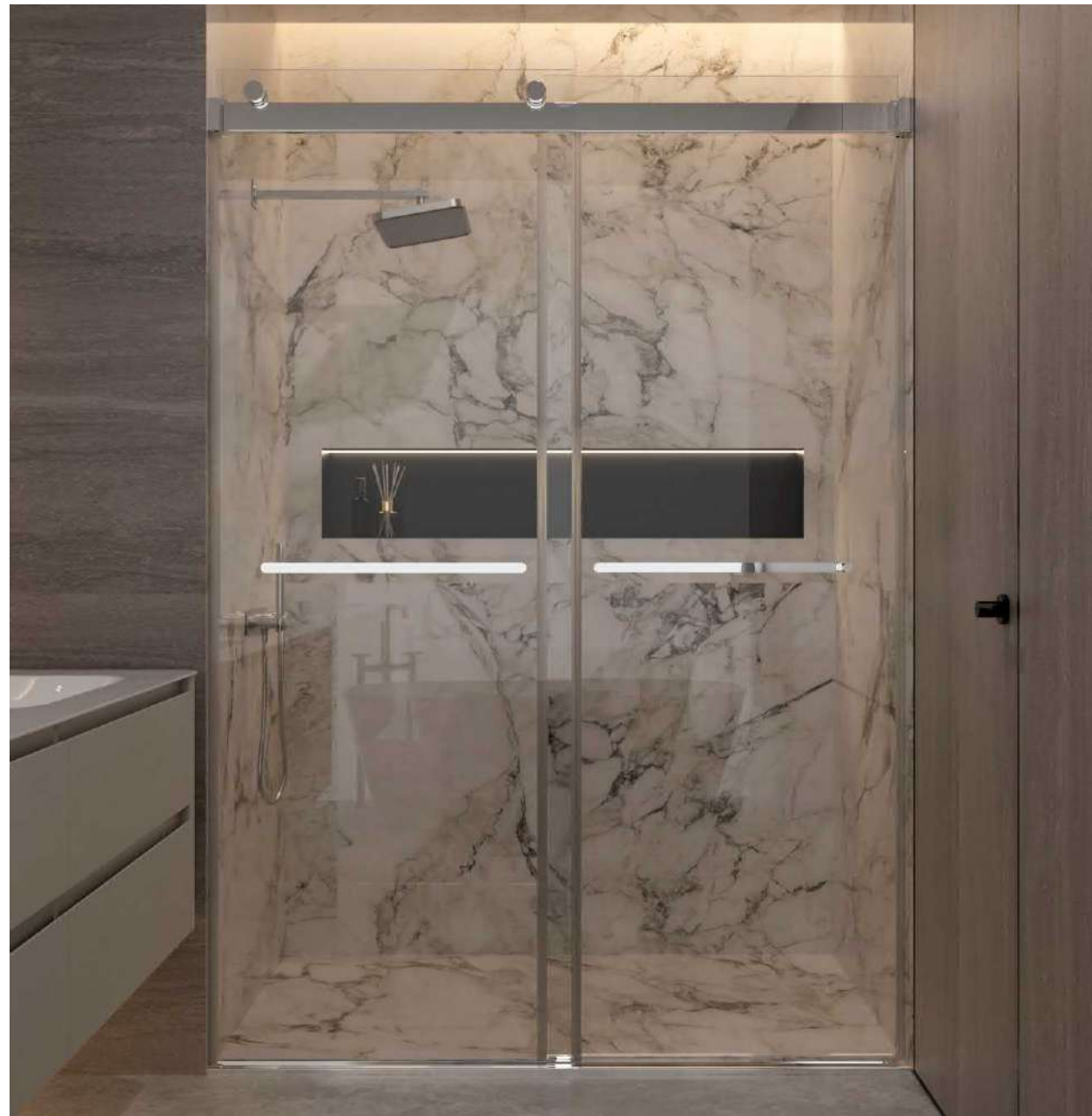

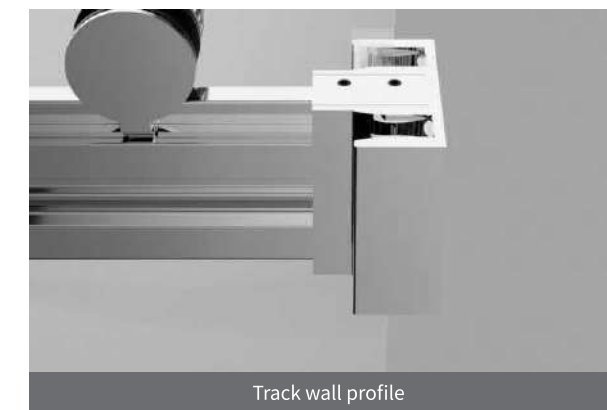
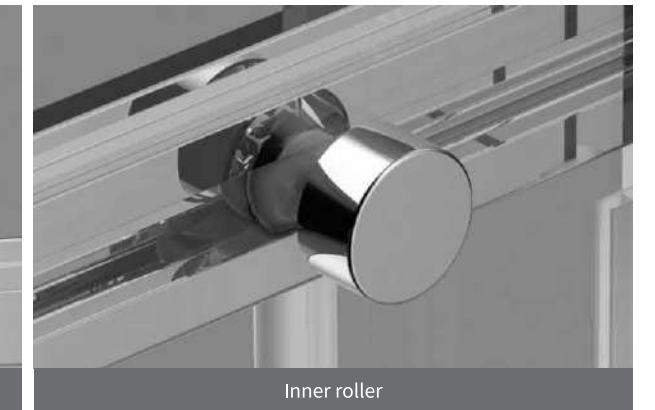

FRAME MATERIAL: Aluminium frame

FRAME COLORS

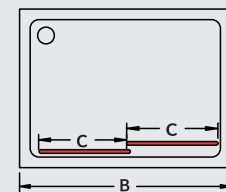

Width B	Adjustment min-max B	Door opening C
1000	980-1000	450
1100	1080-1100	500
1200	1180-1200	550
1300	1280-1300	600
1400	1380-1400	650
1500	1480-1500	700



- 
8 mm
GLASS THICKNESS
- 
2000
HEIGHT
- 
76 mm
PRODUCT ADJUSTMENT
- 
REVERSIBLE FOR LEFT OR RIGHT
- 
ALL SCREWS ARE HIDDEN
- 
SWITCH-DOOR BUFFER STRUCTURE

*Other handles are available. For more information, please see page 13.



FRAME MATERIAL: Aluminium frame

FRAME COLORS



Outer large hanging roller



Inner roller



Track wall profile

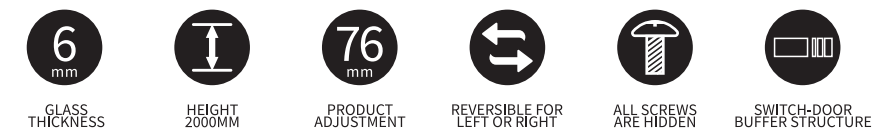

*Other handles are available. For more information, please see page 13.



Width B	Adjustment min-max B	Door opening C
1000	980-1000	460
1100	1080-1100	510
1200	1180-1200	560
1300	1280-1300	610
1400	1380-1400	660
1500	1480-1500	710

The diagram shows a rectangular shower enclosure door. The total width is labeled 'B'. The door opening is labeled 'C'. There are two 'C' labels indicating the distance from the side walls to the door frame.

Width B	Adjustment min-max B	Door opening C
700	680-690	
800	740-750	
900	780-790	
1000	980-990	

The diagram shows a rectangular shower enclosure door. The total width is labeled 'B'. A small circle is visible in the top right corner of the door frame.



FRAME MATERIAL: Stainless steel frame

FRAME COLORS



Outer large hanging roller



Inner roller



Wall clamp block

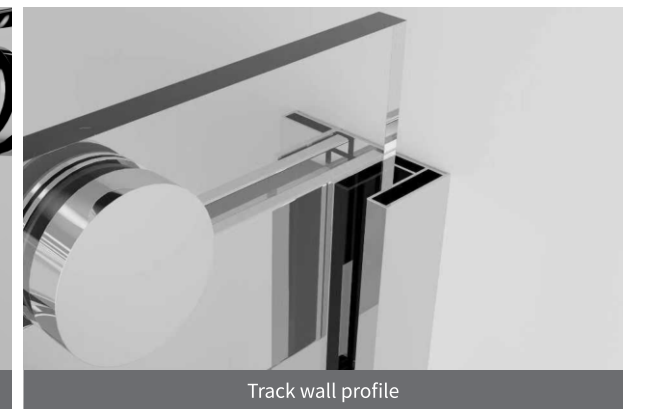

Track wall profile

Width B	Adjustment min-max B	Door opening C
1000	980-1000	426
1100	1080-1100	476
1200	1180-1200	526
1300	1280-1300	576
1400	1380-1400	626
1500	1480-1500	676

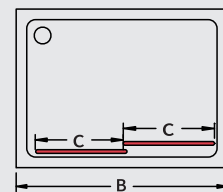

*Other handles are available. For more information, please see page 13.

Shower door / PP SERIES



FRAME MATERIAL: Stainless steel frame

FRAME COLORS

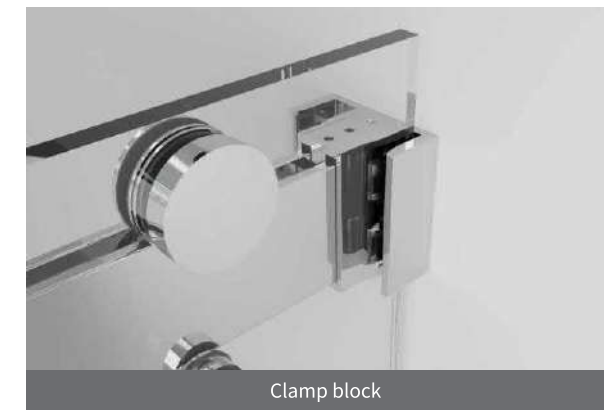
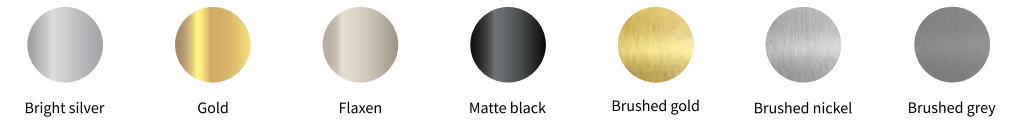

- 10** mm
GLASS THICKNESS
- 2000** mm
HEIGHT
- 76** mm
PRODUCT ADJUSTMENT
- REVERSIBLE FOR LEFT OR RIGHT
- ALL SCREWS ARE HIDDEN
- SWITCH-DOOR BUFFER STRUCTURE

*Other handles are available. For more information, please see page 13.



Width B	Adjustment min-max B	Door opening C
1000	980-1000	460
1100	1080-1100	510
1200	1180-1200	560
1300	1280-1300	610
1400	1380-1400	660
1500	1480-1500	710

Width B	Adjustment min-max B	Door opening C
700	680-690	
800	740-750	
900	780-790	
1000	980-990	



FRAME MATERIAL: Stainless steel frame

FRAME COLORS

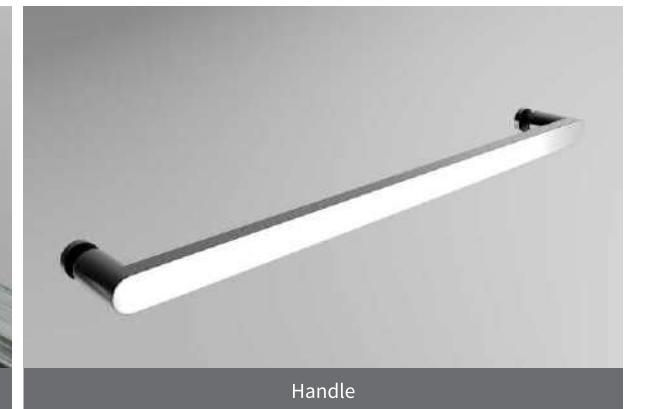
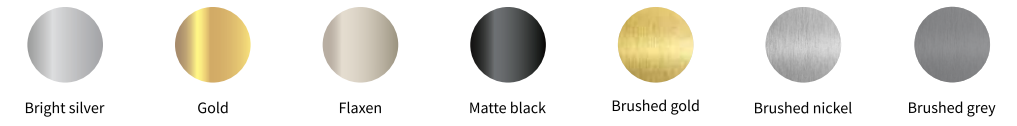

Width B	Adjustment min-max B	Door opening C
1000	980-1000	460
1100	1080-1100	510
1200	1180-1200	560
1300	1280-1300	610
1400	1380-1400	660
1500	1480-1500	710

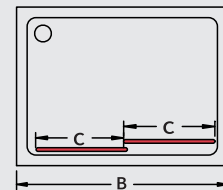



FRAME MATERIAL: Stainless steel frame

FRAME COLORS



Width B	Adjustment min-max B	Door opening C
700	680-690	598
760	740-750	658
800	780-790	698
900	880-890	798

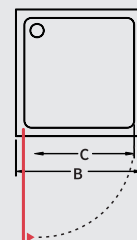

- 

10
mm
GLASS THICKNESS
- 

HEIGHT
2000MM
- 

15
mm
PRODUCT ADJUSTMENT
- 

REVERSIBLE FOR
LEFT OR RIGHT
- 

ALL SCREWS
ARE HIDDEN

*Other handles are available. For more information, please see page 13.



Width B	Adjustment min-max B	Door opening C
900	885-900	588
1000	985-1000	688
1100	1085-1100	688
1200	1185-1200	688
1400	1385-1400	688
1500	1485-1500	688
1600	1585-1600	688
1700	1685-1700	688

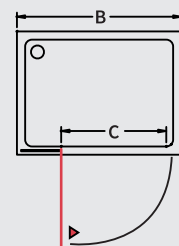

Width B	Adjustment min-max B	Door opening C
700	680-695	
760	740-755	
800	780-795	
900	980-995	

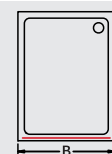

Bottom door system



Width B	Adjustment min-max B	Door opening C
800	785-800	558
900	885-900	558
1000	985-1000	558
1000	1085-1100	558
1200	1185-1200	558

